

Vickers®

Cylinders



Series VN/VP Cylinders

Nominal Pressure: 250 psi Air, 400 psi Hydraulic

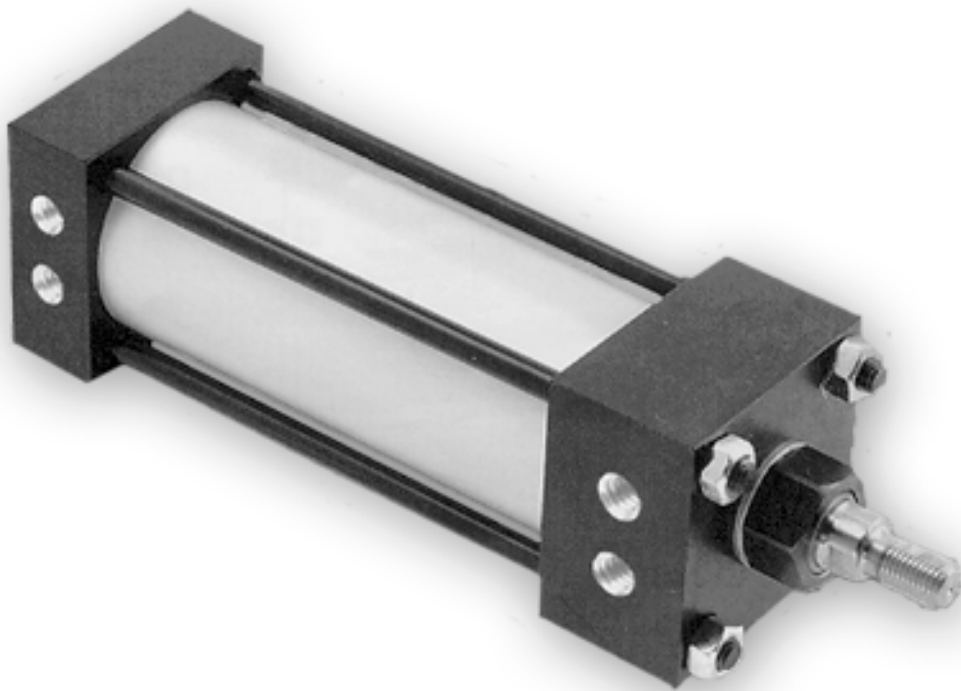

Contents

Features	4
How to Order	5
Model Code	6
Mounting Styles	8
Mounting Style & Installation Dimensions: 1-1/2 thru 8 inch Bores	
Code 01 Side Lug Mounts (MS2)	11
Code 02 Tapped Mounts (MS4)	12
Code 03 End Lug Mounts (MS7)	13
Code 07 Head Rectangular Flange Mounts (MF1)	14
Code 08 Head Square Mounts (ME3)	15
Code 10 Fixed Clevis Mounts (MP1)	16
Code 12 Cap Rectangular Flange Mounts (MF2)	17
Code 13 Cap Square Mounts (ME4)	18
Code 16 Cap Trunnion Mounts (MT2)	19
Code 17 Head Trunnion Mounts (MT1)	20
Code 18 Sleeve Nut for Tapped Face Mounts	21
Code 21 Cap Extended Tie Rod Mounts (MX2)	22
Code 22 Head Extended Tie Rod Mounts (MX3)	22
Code 23 Both Ends Extended Tie Rod Mounts (MX1)	22
Code 24 No Mounts (MX0)	23
Code 41 Double Rod, No Mounts	24
Code 45 Angle Mounts (MS1)	25
Code 48 Detachable Eye Mounts (MP4)	26
Code 50 Detachable Clevis Mounts (MP2)	27
Accessories: 1-1/2 thru 8 inch Bores	28
Rod Alignment Coupler	30
Optional Rod Ends: 1-1/2 thru 8 inch Bores	31
Mounting Style & Installation Dimensions: 3/4 & 1-1/8 inch Bores	
Code 01 Bolt Thru Mounts (MS8)	32
Code 02 Tapped Mounts (MS9)	32
Code 07 Head Rectangular Flange Mounts (MF1)	32
Code 12 Cap Rectangular Flange Mounts (MF2)	34
Code 18 Head Tapped Face Mounts (MR1)	34
Code 20 Threaded Nose Mounts (MNR1)	34
Code 24 No Mounts (MX0)	36
Code 25 Double Rod, Bolt Thru Mounts	36
Code 47 Fixed Eye Mounts (MP3)	36
Code 48 Detachable Eye Mounts (MP4)	38
Code 50 Detachable Clevis Mounts (MP2)	38
Rod Ends for 3/4 & 1-1/8 inch Bores	40
Accessories for 3/4 & 1-1/8 inch Bores	41
Switches for 3/4 thru 8 inch Bores	42
Technical Information – Application / Engineering Data	44
Stop Tubes	45

Features

Wiper Seal.

Urethane wiper seal keeps contaminants from getting into cylinder by aggressively wiping foreign materials from the piston rod, enhancing the rod seal life.

Head/Cap.

Precision machined from alloy aluminum, then black anodized for corrosion resistance in Series VP, and electroless nickel plated for Series VN option.

Adjustable Captive Cushion Adjusting Screw.

One-piece stainless steel cushion screw with fine threads is held captive by a stainless steel press-in retaining washer. This allows for safe and precise adjustment of the cushion without inadvertent removal.

Cylinder Body.

High-strength aluminum alloy tubing is clear anodized on the O.D. and hard anodic coated on the I.D., resulting in a smooth, file hard (60RC), corrosion and score resistant surface finish for extended seal life in Series VP. Stainless steel tubing is used in Series VN option.

Tie Rods.

High-strength steel in Series VP, and stainless steel for Series VN option, maintains uniform compression on body end seals.

Wear Ring.

Reinforced Teflon® compounded with polyphenylene sulfide provides supreme wear and excellent bearing support.

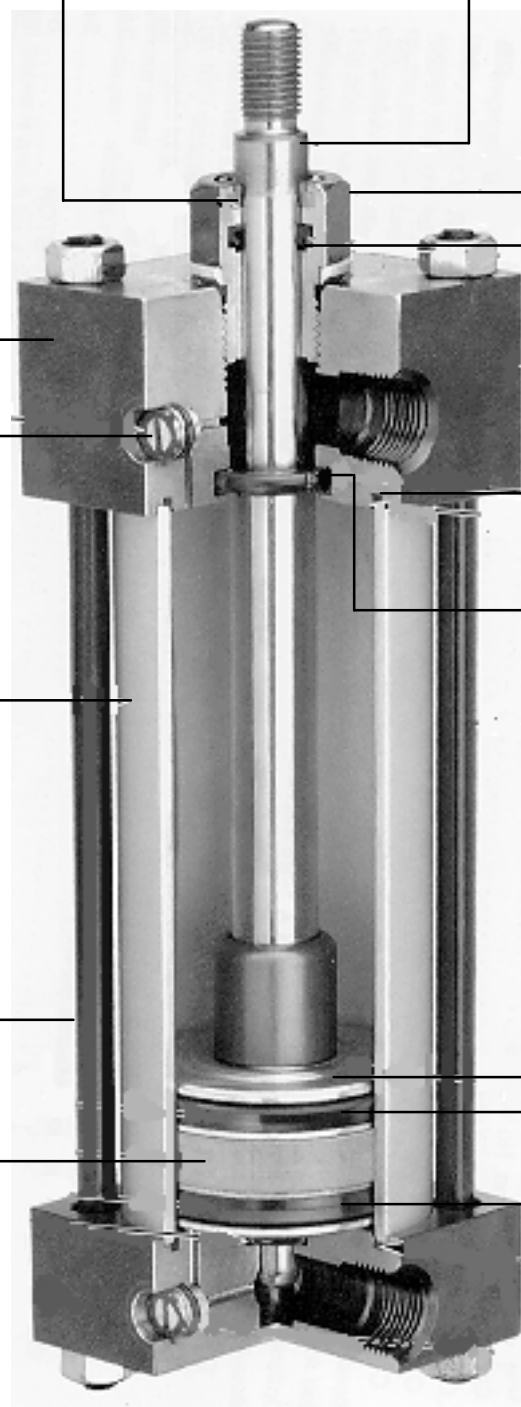

Piston Rod.

Hard chrome plated high-tensile carbon steel, ground and polished in Series VP, and stainless steel for Series VN option.

Rod Bearing.

Externally removable threaded steel bearing cartridge with black oxide finish in Series VP, or stainless steel for Series VN option, both with an oil-impregnated sintered iron rod bearing.

Rod Seal.

Nitrile lip-type seal is pressure energized and wear compensating for durability and long life.

O-Ring Body Seal:

Nitrile material is standard, with Viton® optional.

Super Cushion Seals.

Advanced design features a unique, one-piece, compound seal of nitrile* captured within a precision machined groove. Linear and radial "float" of the cushion seals eliminates misalignment. Super Cushions provide exceptionally fast "out of cushion" stroke reversal. (Head and Cap Cushions are optional on 1-1/2 thru 8 inch bore cylinders.)

*Nitrile seals on the 5/8" & 1" rod diameter. For rod sizes 1-3/8" and larger, urethane seals are standard.

Piston.

Machined solid aluminum alloy, light-weight for low inertia, yet strong. (Threaded and installed with high strength threadlocker adhesive.)

Piston Seals.

Long-wearing nitrile cup seals.

Teflon® and Viton® are registered trademarks of E.I. Dupont Company.

How To Order

Standard Cylinders

Vickers has created an easy system for ordering Series VN/VP Cylinders. This system has been developed to improve our service to you. The model code consists of sixteen alpha-numeric digits which fully describe the most common standard options offered on Series VN/VP cylinders.

To specify your Series VN/VP cylinder, review the following pages for a full description of each option available and select the desired code.

This model code system will:

- **Simplify the re-order process.**
Each Vickers Series VN/VP cylinder is assigned a sixteen digit model code. That code is unique to a particular cylinder description. That way, when you re-order your Series VN/VP cylinder, you're assured of exactly the same top quality cylinder design.
- **Improve identification.**
Every Series VN/VP cylinder has its sixteen digit model code clearly labeled on the product. Each sixteen digit code completely describes a specific cylinder. This allows seals and replacement components to be easily identified in the field.
- **Facilitate communications.**
This fully descriptive model code system allows you to work directly with your local Vickers sales engineer to identify and service your Vickers cylinder.

NOTE

See pages 6 and 7 for a summary of model code options.

Custom Cylinders

New Cylinders

Although the model code has been arranged to cover the vast majority of available options, there will be occasions when you require an option which cannot be coded. When specifying such an option, enter an "X" for the appropriate item in the sixteen digit model code, then describe your requirements. For example, if you have an application which requires a custom thread on the end of the piston rod, enter an "X" for item 7. Then add a full description at the end of the model code, such as "With 3.25 inch total rod projection and M22 x 1.5 thread 1.375 inches long." The cylinder will then be given a unique five digit design number on receipt of order (as explained below).

Replacement Cylinders

Every Vickers custom cylinder is assigned a unique design number. This number is contained in the last five digits of the sixteen digit model code, and item 12 is always an alpha character. In other words, the "Stroke" and "Extra Rod Projection" locations (items 12 through 16) become the "Design Number" items for custom cylinders. When ordering a replacement cylinder, simply give the sixteen digit model code or the five digit design number to your local Vickers Sales Representative.

Replacement Parts

Each design number is stored in a quick retrieval computerized storage system. This gives our field sales representatives rapid access to assist you in identifying and specifying genuine Vickers replacement parts.

Model Code

VP 10 E A C A 1 A H 108 00

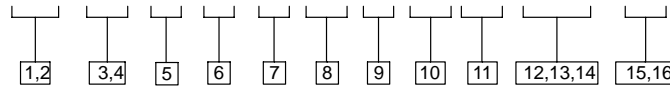

1,2 Series (ANSI B93.15/NFPA)

VP - Non-lubricated air/hydraulic cylinder
VN - Corrosion resistant air cylinder

3,4 Mounting style (see pgs. 6-8)

Vickers Code	Style	ANSI Code
	1-1/2" thru 8" Bore	
01	Side lug	MS2
02	Side tapped	MS4
03	End lug	MS7
07	Head rectangular flange	MF1
08	Head square	ME3
10	Cap fixed clevis	MP1
12	Cap rectangular flange	MF2
13	Cap square	ME4
16	Cap trunnion	MT2
17	Head trunnion	MT1
18	Sleeve nut for tapped face	-
21	Cap extended tie rod	MX2
22	Head extended tie rod	MX3
23	Both ends extended tie rod	MX1
24	No mounts	MX0
41	Double rod, no mounts	-
45	Angle	MS1
48	Detachable eye	MP4
50	Detachable clevis	MP2
	3/4" thru 1-1/8" Bore	
01	Bolt thru	MS8
02	Tapped	MS9
07	Head rectangular flange	MF1
12	Cap rectangular flange	MF2
18	Head tapped face	MR1
20	Threaded nose	MNR1
24	No mounts	MX0
25	Double rod w/bolt thru	-
47	Fixed eye	MP3
48	Detachable eye	MP4
50	Detachable clevis	MP2

5 Bore size

Code	Bore Size
A	3/4
1	1-1/8
C	1-1/2
D	2
E	2-1/2
G	3-1/4
H	4
K	5
L	6
M	7
N	8

6 Cushion location

Cushions are located as shown below when viewing cylinder from head end (mounting end of double rod cylinders). "-" in table indicates no cushion.

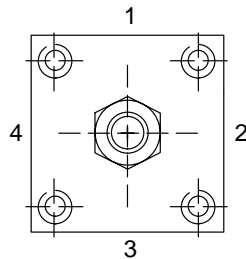

Code	Head	Cap
A	-	-
B	-	1
C	-	2
D	-	3
E	-	4
F	1	-
G	2	-
H	3	-
J	4	-
K	1	1
R	2	2
S	2	3
T	2	4
V	3	2
W	3	3
Y	3	4
4	4	4

7 Rod size and type

Bore Size	Rod Size	Rod End Type				
		2	9	5	6	S
3/4	5/16	A	B	C	D	S
1-1/8	3/8	A	B	C	D	S
1-1/8	1/2	E	F	G	H	T
1-1/2	5/8	A	B	C	D	S
1-1/2	1	E	F	G	H	T
2	5/8	A	B	C	D	S
2	1	E	F	G	H	T
2-1/2	5/8	A	B	C	D	S
2-1/2	1	E	F	G	H	T
3-1/4	1	A	B	C	D	S
3-1/4	1-3/8	E	F	G	H	T
4	1	A	B	C	D	S
4	1-3/8	E	F	G	H	T
5	1	A	B	C	D	S
5	1-3/8	E	F	G	H	T
6	1-3/8	A	B	C	D	S
6	1-3/4	E	F	G	H	T
7	1-3/8	A	B	C	D	S
7	1-3/4	E	F	G	H	T
8	1-3/8	A	B	C	D	S
8	1-3/4	E	F	G	H	T

Type 2 Female UN Thread

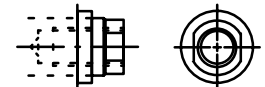

Type 5 Small Male UN Thread

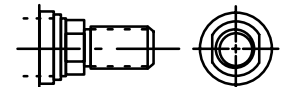

Type 6 Plain No Attachment

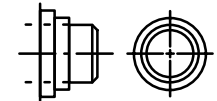

Type 9 Intermediate Male UN Thread

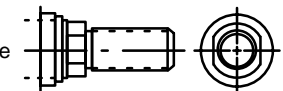

Type S Studded Female UN Thread

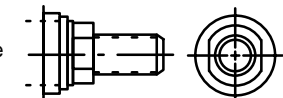

Double Rod Cylinders:
 "Head" = "Mounting End"
 "Cap" = "Non-mounting End"

8 Seal options	Code
Nitrile (Standard)	A
High Temperature Viton®	T

9 Port options	Code
NPTF Dryseal (Standard)	1
NPTF Dryseal (Oversized)	2

10 Port locations
Positions are numbers as shown in item 6.

Code	Port Locations
A	1
F	2
L	3
S	4

11 Proximity switch magnet	Code	Magnet Type
N		Magnet not required (no proximity switch option)
H		Magnet furnished to operate Hall Effect or Reed type switch

Note: Switches will not function as designed without the magnet installed.

12,13,14 Cylinder stroke
Items 12 and 13 indicate stroke length from 00 inches through 99 inches.
Item 14 indicates fraction of an inch per the following codes:

Code	Fraction	Code	Fraction
0	0	8	1/2
1	1/16	9	9/16
2	1/8	A	5/8
3	3/16	B	11/16
4	1/4	C	3/4
5	5/16	D	13/16
6	3/8	E	7/8
7	7/16	F	15/16

15,16 Extra rod projection
Item 15 indicates inches from **0** thru **9**.
Item 16 indicates fraction of an inch per the following codes:

Code	Fraction	Code	Fraction
0	0	8	1/2
1	1/16	9	9/16
2	1/8	A	5/8
3	3/16	B	11/16
4	1/4	C	3/4
5	5/16	D	13/16
6	3/8	E	7/8
7	7/16	F	15/16

Viton® is a registered trademark of E.I. Dupont Company.

Mounting Style: 1-1/2 – 8 inch Bores

Available Mountings

The variety of standard ANSI/NFPA mountings available in the Series VN/VP gives you a broad selection to match the proper mount to your application.

Vickers offers rigid mounts (including side lug mounts, flange mounts, and extended tie rod mounts) and swivel mounts (including clevis mounts and trunnion mounts). A guide to proper mount selection is provided on pages # through ##. For custom mounts, enter "XX" for model code positions 3 and 4, and give a detailed description with drawings. Series VN/VP cylinders are available in all mounting styles listed.

Selecting the Proper Mounting

Just as the cylinder bore must be sized to provide the proper force for an application, a cylinder mounting that can absorb these application forces must also be specified. Note: In the mounting information, some mounts have been downrated to minimize deflection. For applications where the motion is linear and parallel to the cylinder rod motion, a rigid mount is recommended. For curvilinear motion, a swivel mount should be chosen. The specifics of each application dictate the correct mounting style.

**Code 01 (MS2)
Side Lug**

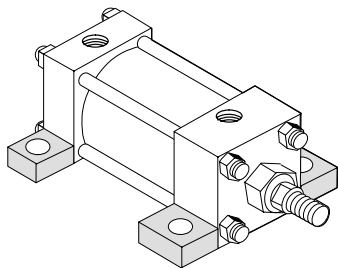

**Code 02 (MS4)
Tapped**

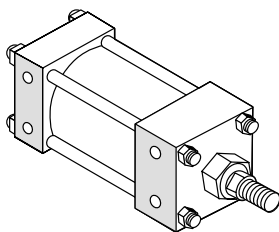

**Code 03 (MS7)
End Lug**

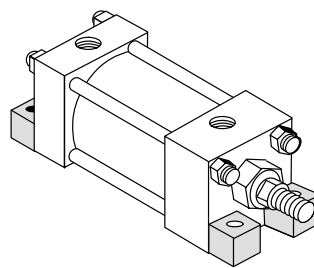

**Code 07 (MF1)
Head Rectangular Flange**

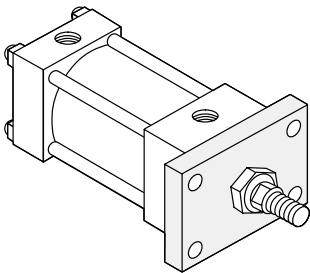

**Code 08 (ME3)
Head Square**

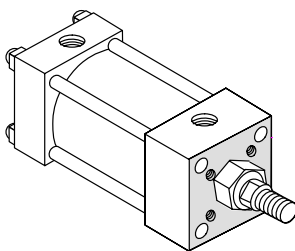

**Code 10 (MP1)
Cap Fixed Clevis**

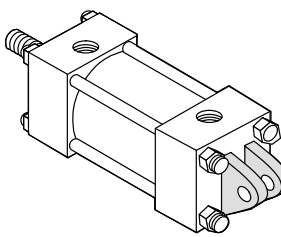

**Code 12 (MF2)
Cap Rectangular Flange**

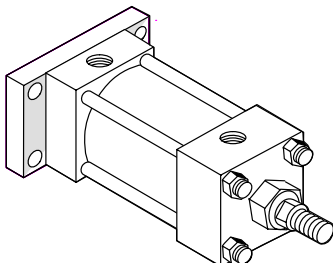

**Code 13 (ME4)
Cap Square**

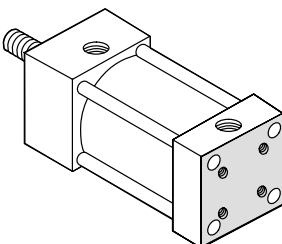

**Code 16 (MT2)
Cap Trunnion**

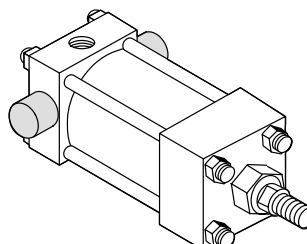

**Code 17 (MT2)
Head Trunnion**

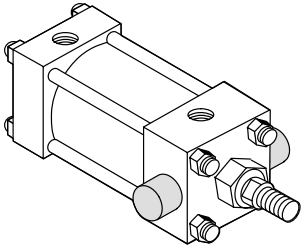

**Code 18 Sleeve Nut
Construction for
Tapped Faces**

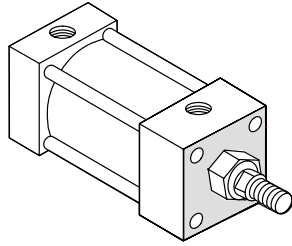

**Codes 21 (MX2) Cap, 22 (MX3)
head, 23 (MX1) Extended Tie Rod**

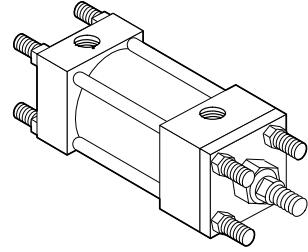

**Code 24 (MX0)
No Mounts**

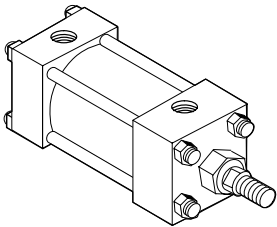

**Double Rod
Code 41 (MX0)
No Mounts**

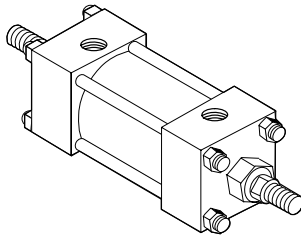

**Code 45 (MS1)
Angle**

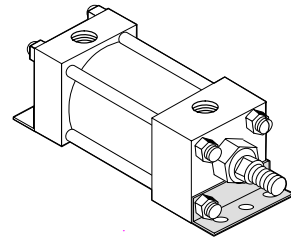

**Code 48 (MP4)
Cap Detachable Eye**

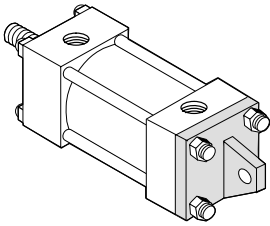

**Code 50 (MP2)
Cap Detachable Clevis**

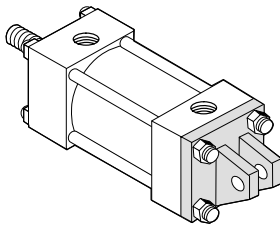

Mounting Style: 3/4 & 1-1/8 inch Bores

Code 01 (MS8)
Bolt Thru

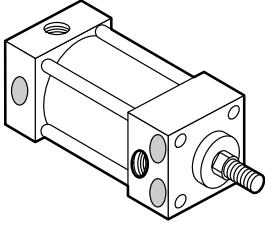

Code 02 (MS9)
Tapped

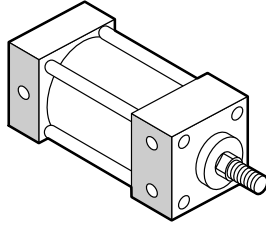

Code 07 (MF1)
Head Rectangular Flange

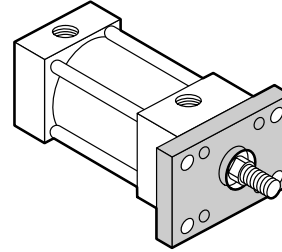

Code 12 (MF2)
Cap Rectangular Flange

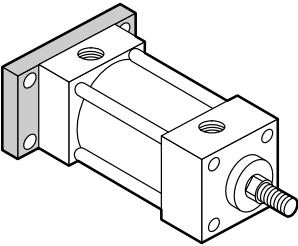

Code 18 (MR1)
Head Tapped Face

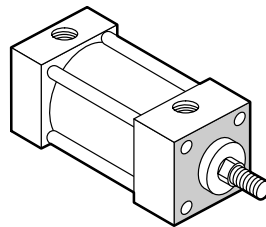

Code 20 (MNR1)
Threaded Nose Mounts

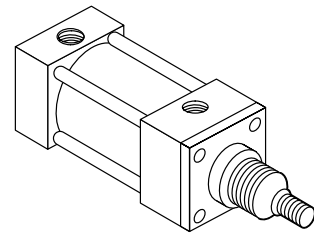

Code 24 (MX0)
No Mounts

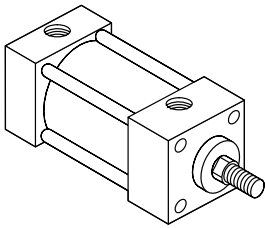

Code 25 Double Rod,
Bolt Thru

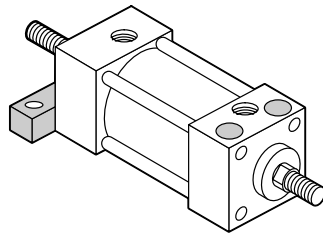

Code 47 (MP3)
Fixed Eye

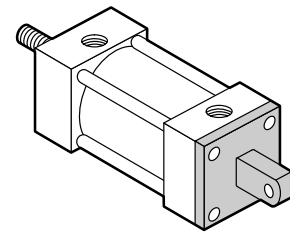

Code 48 (MP4)
Detachable Eye

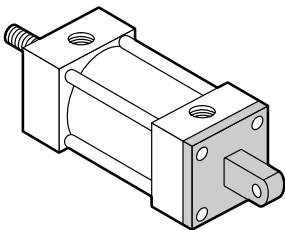

Code 50 (MP2)
Detachable Clevis

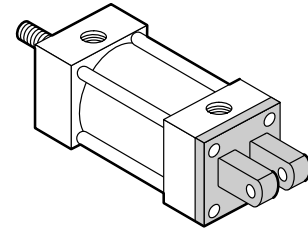

Series VN/VP Mounting Styles and Installation Dimensions

Code 01 Side Lug Mounts (ANSI MS2)

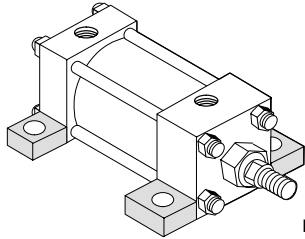

Side lug mounts are for moving loads along a flat guided surface as in a carriage along rails.

The mounting surface should be flat and parallel to the centerline of the piston rod.

The load should be guided to transverse along the centerline of the piston rod. The frame on which the cylinder is mounted must be sufficiently rigid to resist bending moments.

NOTE

Limit operating pressure to 400 psi (27 bar) non-shock hydraulic for minimum deflection. For strokes in excess of 30 inches, see "Stop Tube Selection" on page 45.

With unsupported loads, the bearing must absorb more force. For these applications, the larger available rod is recommended, and stop tubes should be considered.

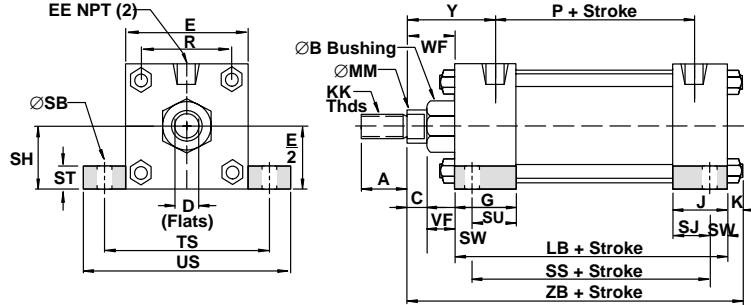

Dimension	1 1/2" Bore (38.10)	2" Bore (50.80)	2 1/2" Bore (63.50)	3 1/4" Bore (82.55)	4" Bore (101.60)	5" Bore (127.00)	6" Bore (152.40)	7" Bore (177.80)	8" Bore (203.20)
Ø Rod	Std. 5/8" (15.88)	5/8" (15.88)	5/8" (15.88)	1" (25.40)	1" (25.40)	1" (25.40)	1-3/8" (34.93)	1-3/8" (34.93)	1-3/8" (34.93)
	O.S. 1" (25.40)	1" (25.40)	1" (25.40)	1-3/8" (34.93)	1-3/8" (34.93)	1-3/8" (34.93)	1-3/4" (44.45)	1-3/4" (44.45)	1-3/4" (44.45)
A	Std. .750 (19.05)	.750 (19.05)	.750 (19.05)	1.125 (28.58)	1.125 (28.58)	1.125 (28.58)	1.625 (41.28)	1.625 (41.28)	1.625 (41.28)
	O.S. 1.125 (28.58)	1.125 (28.58)	1.125 (28.58)	1.625 (41.28)	1.625 (41.28)	1.625 (41.28)	2.000 (50.80)	2.000 (50.80)	2.000 (50.80)
B ^{+0.000} B _{-0.002}	Std. 1.124 (28.55)	.750 (19.05)	.750 (19.05)	1.125 (28.58)	1.125 (28.58)	1.125 (28.58)	1.625 (41.28)	1.625 (41.28)	1.625 (41.28)
	O.S. 1.499 (38.08)	1.125 (28.58)	1.125 (28.58)	1.625 (41.28)	1.625 (41.28)	1.625 (41.28)	2.000 (50.80)	2.000 (50.80)	2.000 (50.80)
C	Std. .375 (9.53)	.375 (9.53)	.375 (9.53)	.500 (12.70)	.500 (12.70)	.500 (12.70)	.625 (15.88)	.625 (15.88)	.625 (15.88)
	O.S. .500 (12.70)	.500 (12.70)	.500 (12.70)	.625 (15.88)	.625 (15.88)	.625 (15.88)	.750 (19.05)	.750 (19.05)	.750 (19.05)
CC	Std. 1/2 - 20	1/2 - 20	1/2 - 20	7/8 - 14	7/8 - 14	7/8 - 14	1-1/4 - 12	1-1/4 - 12	1-1/4 - 12
	O.S. 7/8 - 14	7/8 - 14	7/8 - 14	1-1/4 - 12	1-1/4 - 12	1-1/4 - 12	1-1/2 - 12	1-1/2 - 12	1-1/2 - 12
D	Std. .500 (12.70)	.500 (12.70)	.500 (12.70)	.813 (20.64)	.813 (20.64)	.813 (20.64)	1.125 (28.58)	1.125 (28.58)	1.125 (28.58)
	O.S. .813 (20.64)	.813 (20.64)	.813 (20.64)	1.125 (28.58)	1.125 (28.58)	1.125 (28.58)	1.500 (38.10)	1.500 (38.10)	1.500 (38.10)
E	2.000 (50.80)	2.500 (63.50)	3.000 (76.20)	3.750 (95.25)	4.500 (114.30)	5.500 (139.70)	6.500 (165.10)	7.500 (190.50)	8.500 (215.90)
EE	.375 (9.53)	.375 (9.53)	.375 (9.53)	.500 (12.70)	.500 (12.70)	.500 (12.70)	.750 (19.05)	.750 (19.05)	.750 (19.05)
FF	Std. 5/8 - 18	5/8 - 18	5/8 - 18	1 - 14	1 - 14	1 - 14	1-3/8 - 12	1-3/8 - 12	1-3/8 - 12
	O.S. 1 - 14	1 - 14	1 - 14	1-3/8 - 12	1-3/8 - 12	1-3/8 - 12	1-3/4 - 12	1-3/4 - 12	1-3/4 - 12
G	1.500 (38.10)	1.500 (38.10)	1.500 (38.10)	1.750 (44.45)	1.750 (44.45)	1.750 (44.45)	2.000 (50.80)	2.000 (50.80)	2.000 (50.80)
J	1.000 (25.40)	1.000 (25.40)	1.000 (25.40)	1.250 (31.75)	1.250 (31.75)	1.250 (31.75)	1.500 (38.10)	1.500 (38.10)	1.500 (38.10)
K	.250 (6.35)	.313 (7.94)	.313 (7.94)	.375 (9.53)	.375 (9.53)	.438 (11.11)	.438 (11.11)	.563 (14.29)	.563 (14.29)
KK	Std. 7/16 - 20	7/16 - 20	7/16 - 20	3/4 - 16	3/4 - 16	3/4 - 16	1 - 14	1 - 14	1 - 14
	O.S. 3/4 - 16	3/4 - 16	3/4 - 16	1 - 14	1 - 14	1 - 14	1-1/4 - 12	1-1/4 - 12	1-1/4 - 12
LB	3.625 (92.08)	3.625 (92.08)	3.750 (95.25)	4.250 (107.95)	4.250 (107.95)	4.500 (114.30)	5.000 (127.00)	5.125 (130.18)	5.125 (130.18)
MM	Std. .625 (15.88)	.625 (15.88)	.625 (15.88)	1.000 (25.40)	1.000 (25.40)	1.000 (25.40)	1.375 (34.93)	1.375 (34.93)	1.375 (34.93)
	O.S. 1.000 (25.40)	1.000 (25.40)	1.000 (25.40)	1.375 (34.93)	1.375 (34.93)	1.375 (34.93)	1.750 (44.45)	1.750 (44.45)	1.750 (44.45)
P	2.313 (58.74)	2.313 (58.74)	2.438 (61.91)	2.625 (66.68)	2.625 (66.68)	2.875 (73.03)	3.125 (79.38)	3.250 (82.55)	3.250 (82.55)
R	1.428 (36.27)	1.838 (46.68)	2.192 (55.67)	2.758 (70.05)	3.323 (84.40)	4.101 (104.16)	4.879 (123.92)	5.639 (145.54)	6.442 (163.63)
SB	.438 (11.11)	.438 (11.11)	.438 (11.11)	.563 (14.29)	.563 (14.29)	.813 (20.64)	.813 (20.64)	.813 (20.64)	.813 (20.64)
SH	1.000 (25.40)	1.250 (31.75)	1.500 (38.10)	1.875 (47.63)	2.250 (57.15)	2.750 (69.85)	3.250 (82.55)	3.750 (95.25)	4.250 (107.95)
SJ	.625 (15.88)	.625 (15.88)	.625 (15.88)	.750 (19.05)	.750 (19.05)	.813 (20.64)	.813 (20.64)	.813 (20.64)	.813 (20.64)
SS	2.875 (73.03)	2.875 (73.03)	3.000 (76.20)	3.250 (82.55)	.750 (19.05)	.813 (20.64)	.813 (20.64)	.813 (20.64)	.813 (20.64)
ST	.500 (12.70)	.500 (12.70)	.500 (12.70)	.750 (19.05)	.750 (19.05)	1.000 (25.40)	1.000 (25.40)	1.000 (25.40)	1.000 (25.40)
SU	1.125 (28.58)	1.125 (28.58)	1.125 (28.58)	1.250 (31.75)	1.250 (31.75)	1.063 (26.99)	1.313 (33.34)	1.313 (33.34)	1.313 (33.34)
SW	.375 (9.53)	.375 (9.53)	.375 (9.53)	.500 (12.70)	.500 (12.70)	.688 (17.46)	.688 (17.46)	.688 (17.46)	.688 (17.46)
TS	2.750 (69.85)	3.250 (82.55)	3.750 (95.25)	4.750 (120.65)	5.500 (139.70)	6.875 (174.63)	7.875 (200.03)	8.875 (225.43)	9.875 (250.83)
US	3.500 (88.90)	4.000 (101.60)	4.500 (114.30)	5.750 (146.05)	6.500 (165.10)	8.250 (209.55)	9.250 (234.95)	10.250 (260.35)	11.250 (285.75)
VF	Std. .625 (15.88)	.625 (15.88)	.625 (15.88)	.875 (22.23)	.875 (22.23)	.875 (22.23)	1.000 (25.40)	1.000 (25.40)	1.000 (25.40)
	O.S. .875 (22.23)	.875 (22.23)	.875 (22.23)	1.000 (25.40)	1.000 (25.40)	1.000 (25.40)	1.125 (28.58)	1.125 (28.58)	1.125 (28.58)
WF	Std. 1.000 (25.40)	1.000 (25.40)	1.000 (25.40)	1.375 (34.93)	1.375 (34.93)	1.375 (34.93)	1.625 (41.28)	1.625 (41.28)	1.625 (41.28)
	O.S. 1.375 (34.93)	1.375 (34.93)	1.375 (34.93)	1.625 (41.28)	1.625 (41.28)	1.625 (41.28)	1.875 (47.63)	1.875 (47.63)	1.875 (47.63)
XS	Std. 1.375 (34.93)	1.375 (34.93)	1.375 (34.93)	1.875 (47.63)	1.875 (47.63)	2.062 (52.37)	2.313 (58.74)	2.313 (58.74)	2.313 (58.74)
	O.S. 1.750 (44.45)	1.750 (44.45)	1.750 (44.45)	2.125 (53.98)	2.125 (53.98)	2.313 (58.74)	2.562 (65.07)	2.562 (65.07)	2.562 (65.07)
Y	Std. 1.875 (47.63)	1.875 (47.63)	1.875 (47.63)	2.438 (61.91)	2.438 (61.91)	2.438 (61.91)	2.813 (71.44)	2.813 (71.44)	2.813 (71.44)
	O.S. 2.250 (57.15)	2.250 (57.15)	2.250 (57.15)	2.688 (68.26)	2.688 (68.26)	2.688 (68.26)	3.063 (77.79)	3.063 (77.79)	3.063 (77.79)
ZB	Std. 4.875 (123.83)	4.938 (125.41)	5.063 (128.59)	6.000 (152.40)	6.000 (152.40)	6.313 (160.34)	7.063 (179.39)	7.313 (185.74)	7.313 (185.74)
	O.S. 5.250 (133.35)	5.313 (134.94)	5.438 (138.11)	6.250 (158.75)	6.250 (158.75)	6.563 (166.69)	7.313 (185.74)	7.563 (192.09)	7.563 (192.09)

All dimensions in inches (mm)

Code 02 Tapped Mounts (ANSI MS4)

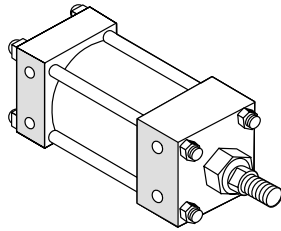

Tapped mounts are for moving loads along a flat guided surface as in a carriage along rails. The mounting surface should be flat and parallel to the centerline of the piston rod.

The load should be guided to traverse along the centerline of the piston rod. The frame on which the cylinder is mounted must be sufficiently rigid to resist bending moments.

NOTE

For strokes in excess of 30 inches, see "Stop Tube Selection" on page 45.

With unsupported loads, the bearing must absorb more force. For these applications, the larger available rod is recommended, and stop tubes should be considered.

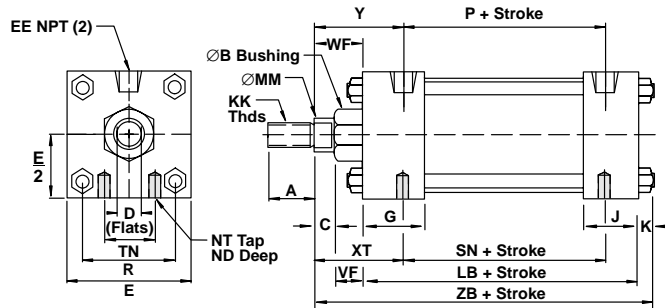

Dimension		1 1/2" Bore (38.10)	2" Bore (50.80)	2 1/2" Bore (63.50)	3 1/4" Bore (82.55)	4" Bore (101.60)	5" Bore (127.00)	6" Bore (152.40)	7" Bore (177.80)	8" Bore (203.20)
Ø Rod	Std.	5/8" (15.88)	5/8" (15.88)	5/8" (15.88)	1" (25.40)	1" (25.40)	1" (25.40)	1-3/8" (34.93)	1-3/8" (34.93)	1-3/8" (34.93)
	O.S.	1" (25.40)	1" (25.40)	1" (25.40)	1-3/8" (34.93)	1-3/8" (34.93)	1-3/8" (34.93)	1-3/4" (44.45)	1-3/4" (44.45)	1-3/4" (44.45)
A	Std.	.750 (19.05)	.750 (19.05)	.750 (19.05)	1.125 (28.58)	1.125 (28.58)	1.125 (28.58)	1.625 (41.28)	1.625 (41.28)	1.625 (41.28)
	O.S.	1.125 (28.58)	1.125 (28.58)	1.125 (28.58)	1.625 (41.28)	1.625 (41.28)	1.625 (41.28)	2.000 (50.80)	2.000 (50.80)	2.000 (50.80)
B _{+0.000} -0.002	Std.	1.124 (28.55)	.750 (19.05)	.750 (19.05)	1.125 (28.58)	1.125 (28.58)	1.125 (28.58)	1.625 (41.28)	1.625 (41.28)	1.625 (41.28)
	O.S.	1.499 (38.08)	1.125 (28.58)	1.125 (28.58)	1.625 (41.28)	1.625 (41.28)	1.625 (41.28)	2.000 (50.80)	2.000 (50.80)	2.000 (50.80)
C	Std.	.375 (9.53)	.375 (9.53)	.375 (9.53)	.500 (12.70)	.500 (12.70)	.500 (12.70)	.625 (15.88)	.625 (15.88)	.625 (15.88)
	O.S.	.500 (12.70)	.500 (12.70)	.500 (12.70)	.625 (15.88)	.625 (15.88)	.625 (15.88)	.750 (19.05)	.750 (19.05)	.750 (19.05)
CC	Std.	1/2 - 20	1/2 - 20	1/2 - 20	7/8 - 14	7/8 - 14	7/8 - 14	1-1/4 - 12	1-1/4 - 12	1-1/4 - 12
	O.S.	7/8 - 14	7/8 - 14	7/8 - 14	1-1/4 - 12	1-1/4 - 12	1-1/4 - 12	1-1/2 - 12	1-1/2 - 12	1-1/2 - 12
D	Std.	.500 (12.70)	.500 (12.70)	.500 (12.70)	.813 (20.64)	.813 (20.64)	.813 (20.64)	1.125 (28.58)	1.125 (28.58)	1.125 (28.58)
	O.S.	.813 (20.64)	.813 (20.64)	.813 (20.64)	1.125 (28.58)	1.125 (28.58)	1.125 (28.58)	1.500 (38.10)	1.500 (38.10)	1.500 (38.10)
E		2.000 (50.80)	2.500 (63.50)	3.000 (76.20)	3.750 (95.25)	4.500 (114.30)	5.500 (139.70)	6.500 (165.10)	7.500 (190.50)	8.500 (215.90)
EE		.375 (9.53)	.375 (9.53)	.375 (9.53)	.500 (12.70)	.500 (12.70)	.500 (12.70)	.750 (19.05)	.750 (19.05)	.750 (19.05)
FF	Std.	5/8 - 18	5/8 - 18	5/8 - 18	1 - 14	1 - 14	1 - 14	1-3/8 - 12	1-3/8 - 12	1-3/8 - 12
	O.S.	1 - 14	1 - 14	1 - 14	1-3/8 - 12	1-3/8 - 12	1-3/8 - 12	1-3/4 - 12	1-3/4 - 12	1-3/4 - 12
G		1.500 (38.10)	1.500 (38.10)	1.500 (38.10)	1.750 (44.45)	1.750 (44.45)	1.750 (44.45)	2.000 (50.80)	2.000 (50.80)	2.000 (50.80)
J		1.000 (25.40)	1.000 (25.40)	1.000 (25.40)	1.250 (31.75)	1.250 (31.75)	1.250 (31.75)	1.500 (38.10)	1.500 (38.10)	1.500 (38.10)
K		.250 (6.35)	.313 (7.94)	.313 (7.94)	.375 (9.53)	.375 (9.53)	.438 (11.11)	.438 (11.11)	.563 (14.29)	.563 (14.29)
KK	Std.	7/16 - 20	7/16 - 20	7/16 - 20	3/4 - 16	3/4 - 16	3/4 - 16	1 - 14	1 - 14	1 - 14
	O.S.	3/4 - 16	3/4 - 16	3/4 - 16	1 - 14	1 - 14	1 - 14	1-1/4 - 12	1-1/4 - 12	1-1/4 - 12
LB		3.625 (92.08)	3.625 (92.08)	3.750 (95.25)	4.250 (107.95)	4.250 (107.95)	4.500 (114.30)	5.000 (127.00)	5.125 (130.18)	5.125 (130.18)
MM	Std.	.625 (15.88)	.625 (15.88)	.625 (15.88)	1.000 (25.40)	1.000 (25.40)	1.000 (25.40)	1.375 (34.93)	1.375 (34.93)	1.375 (34.93)
	O.S.	1.000 (25.40)	1.000 (25.40)	1.000 (25.40)	1.375 (34.93)	1.375 (34.93)	1.375 (34.93)	1.750 (44.45)	1.750 (44.45)	1.750 (44.45)
ND		.375 (9.53)	.375 (9.53)	.500 (12.70)	.750 (19.05)	.750 (19.05)	.938 (23.81)	1.125 (28.58)	1.125 (28.58)	1.125 (28.58)
NT		1/4 - 20	5/16 - 18	3/8 - 18	1/2 - 13	1/2 - 13	5/8 - 11	3/4 - 10	3/4 - 10	3/4 - 10
P		2.313 (58.74)	2.313 (58.74)	2.438 (61.91)	2.625 (66.68)	2.625 (66.68)	2.875 (73.03)	3.125 (79.38)	3.250 (82.55)	3.250 (82.55)
R		1.428 (36.27)	1.838 (46.68)	2.192 (55.67)	2.758 (70.05)	3.323 (84.40)	4.101 (104.16)	4.879 (123.92)	5.639 (142.54)	6.442 (163.63)
SN		2.250 (57.15)	2.250 (57.15)	2.375 (60.33)	2.625 (66.68)	2.625 (66.68)	2.875 (73.03)	3.125 (79.38)	3.250 (82.55)	3.250 (82.55)
TN		.625 (15.88)	.875 (22.23)	1.250 (31.75)	1.500 (38.10)	2.063 (52.37)	2.688 (68.28)	3.250 (82.55)	3.500 (88.90)	4.500 (114.30)
VF	Std.	.625 (15.88)	.625 (15.88)	.625 (15.88)	.875 (22.23)	.875 (22.23)	.875 (22.23)	1.000 (25.40)	1.000 (25.40)	1.000 (25.40)
	O.S.	.875 (22.23)	.875 (22.23)	.875 (22.23)	1.000 (25.40)	1.000 (25.40)	1.000 (25.40)	1.125 (28.58)	1.125 (28.58)	1.125 (28.58)
WF	Std.	1.000 (25.40)	1.000 (25.40)	1.000 (25.40)	1.375 (34.93)	1.375 (34.93)	1.375 (34.93)	1.625 (41.28)	1.625 (41.28)	1.625 (41.28)
	O.S.	1.375 (34.93)	1.375 (34.93)	1.375 (34.93)	1.625 (41.28)	1.625 (41.28)	1.625 (41.28)	1.875 (47.63)	1.875 (47.63)	1.875 (47.63)
XT	Std.	1.938 (49.21)	1.938 (49.21)	1.938 (49.21)	2.438 (61.91)	2.438 (61.91)	2.438 (61.91)	2.813 (71.44)	2.813 (71.44)	2.813 (71.44)
	O.S.	2.313 (58.74)	2.313 (58.74)	2.313 (58.74)	2.688 (68.26)	2.688 (68.26)	2.688 (68.26)	3.063 (77.79)	3.063 (77.79)	3.063 (77.79)
Y	Std.	1.875 (47.63)	1.875 (47.63)	1.875 (47.63)	2.438 (61.91)	2.438 (61.91)	2.438 (61.91)	2.813 (71.44)	2.813 (71.44)	2.813 (71.44)
	O.S.	2.250 (57.15)	2.250 (57.15)	2.250 (57.15)	2.688 (68.26)	2.688 (68.26)	2.688 (68.26)	3.063 (77.79)	3.063 (77.79)	3.063 (77.79)
ZB	Std.	4.875 (123.83)	4.938 (125.41)	5.063 (128.59)	6.000 (152.40)	6.000 (152.40)	6.313 (160.34)	7.063 (179.39)	7.313 (185.74)	7.313 (185.74)
	O.S.	5.250 (133.35)	5.313 (134.94)	5.438 (138.11)	6.250 (158.75)	6.250 (158.75)	6.563 (166.69)	7.313 (185.74)	7.563 (192.09)	7.563 (192.09)

All dimensions in inches (mm)

Code 03 End Lug Mounts (ANSI MS7)

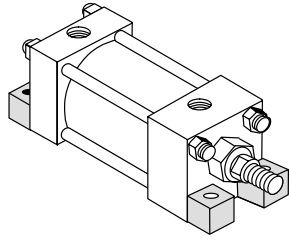

End lug mounts are for moving loads along a flat guided surface as in a carriage along rails. The mounting surface should be flat and parallel to the centerline of the piston rod.

The load should be guided to traverse along the centerline of the piston rod. The frame on which the cylinder is mounted must be sufficiently rigid to resist bending moments.

NOTE

Limit operating pressure to 400 psi (27 bar) non-shock hydraulic for minimum deflection.

For strokes in excess of 30 inches, see "Stop Tube Selection" on page 45.

With unsupported loads, the bearing must absorb more force. For these applications, the larger available rod is recommended, and stop tubes should be considered.

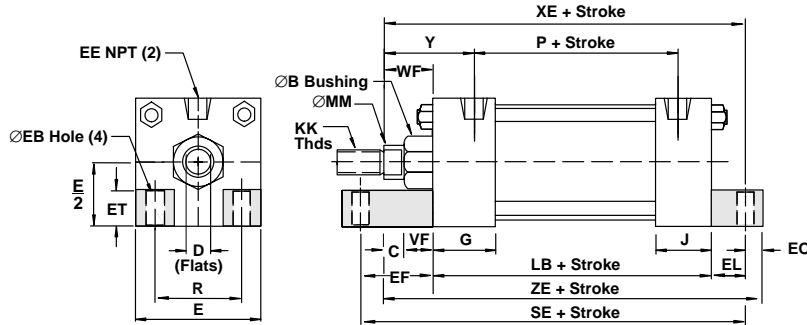

Dimension		1 1/2" Bore (38.10)	2" Bore (50.80)	2 1/2" Bore (63.50)	3 1/4" Bore (82.55)	4" Bore (101.60)	5" Bore (127.00)	6" Bore (152.40)	7" Bore (177.80)	8" Bore (203.20)
ØRod	Std.	5/8" (15.88)	5/8" (15.88)	5/8" (15.88)	1" (25.40)	1" (25.40)	1" (25.40)	1-3/8" (34.93)	1-3/8" (34.93)	1-3/8" (34.93)
	O.S.	1" (25.40)	1" (25.40)	1" (25.40)	1-3/8" (34.93)	1-3/8" (34.93)	1-3/8" (34.93)	1-3/4" (44.45)	1-3/4" (44.45)	1-3/4" (44.45)
A	Std.	.750 (19.05)	.750 (19.05)	.750 (19.05)	1.125 (28.58)	1.125 (28.58)	1.125 (28.58)	1.625 (41.28)	1.625 (41.28)	1.625 (41.28)
	O.S.	1.125 (28.58)	1.125 (28.58)	1.125 (28.58)	1.625 (41.28)	1.625 (41.28)	1.625 (41.28)	2.000 (50.80)	2.000 (50.80)	2.000 (50.80)
B ^{+0.002} _{-0.002}	Std.	1.124 (28.55)	.750 (19.05)	.750 (19.05)	1.125 (28.58)	1.125 (28.58)	1.125 (28.58)	1.625 (41.28)	1.625 (41.28)	1.625 (41.28)
	O.S.	1.499 (38.08)	1.125 (28.58)	1.125 (28.58)	1.625 (41.28)	1.625 (41.28)	1.625 (41.28)	2.000 (50.80)	2.000 (50.80)	2.000 (50.80)
C	Std.	.375 (9.53)	.375 (9.53)	.375 (9.53)	.500 (12.70)	.500 (12.70)	.500 (12.70)	.625 (15.88)	.625 (15.88)	.625 (15.88)
	O.S.	.500 (12.70)	.500 (12.70)	.500 (12.70)	.625 (15.88)	.625 (15.88)	.625 (15.88)	.750 (19.05)	.750 (19.05)	.750 (19.05)
CC	Std.	1/2 - 20	1/2 - 20	1/2 - 20	7/8 - 14	7/8 - 14	7/8 - 14	1-1/4 - 12	1-1/4 - 12	1-1/4 - 12
	O.S.	7/8 - 14	7/8 - 14	7/8 - 14	1-1/4 - 12	1-1/4 - 12	1-1/4 - 12	1-1/2 - 12	1-1/2 - 12	1-1/2 - 12
D	Std.	.500 (12.70)	.500 (12.70)	.500 (12.70)	.813 (20.70)	.813 (20.70)	.813 (20.70)	1.125 (28.58)	1.125 (28.58)	1.125 (28.58)
	O.S.	.813 (20.64)	.813 (20.64)	.813 (20.64)	1.125 (28.58)	1.125 (28.58)	1.125 (28.58)	1.500 (38.10)	1.500 (38.10)	1.500 (38.10)
E		2.000 (50.80)	2.500 (63.50)	3.000 (76.20)	3.750 (95.25)	4.500 (114.30)	5.500 (139.70)	6.500 (165.10)	7.500 (190.50)	8.500 (215.90)
EB		.313 (7.94)	.375 (9.53)	.375 (9.53)	.438 (11.11)	.438 (11.11)	.563 (14.29)	.563 (14.29)	.688 (17.46)	.688 (17.46)
EE		.375 (9.53)	.375 (9.53)	.375 (9.53)	.500 (12.70)	.500 (12.70)	.500 (12.70)	.750 (19.05)	.750 (19.05)	.750 (19.05)
EF		1.125 (28.58)	1.313 (33.34)	1.438 (36.51)	1.500 (38.10)	1.625 (41.28)	1.688 (42.88)	1.750 (44.45)	1.750 (44.45)	1.750 (44.45)
EL		.750 (19.05)	.938 (23.81)	1.063 (26.99)	.875 (22.23)	1.000 (25.40)	1.063 (26.99)	1.000 (25.40)	1.125 (28.58)	1.125 (28.58)
EO		.250 (6.35)	.313 (7.94)	.313 (7.94)	.375 (9.53)	.375 (9.53)	.500 (12.70)	.500 (12.70)	.625 (15.88)	.625 (15.88)
ET		.500 (12.70)	.750 (19.05)	.750 (19.05)	1.000 (25.40)	1.250 (31.75)	1.500 (38.10)	1.500 (38.10)	1.750 (44.45)	2.063 (52.39)
FF	Std.	5/8 - 18	5/8 - 18	5/8 - 18	1 - 14	1 - 14	1 - 14	1-3/8 - 12	1-3/8 - 12	1-3/8 - 12
	O.S.	1 - 14	1 - 14	1 - 14	1-3/8 - 12	1-3/8 - 12	1-3/8 - 12	1-3/4 - 12	1-3/4 - 12	1-3/4 - 12
G		1.500 (38.10)	1.500 (38.10)	1.500 (38.10)	1.750 (44.45)	1.750 (44.45)	1.750 (44.45)	2.000 (50.80)	2.000 (50.80)	2.000 (50.80)
J		1.000 (25.40)	1.000 (25.40)	1.000 (25.40)	1.250 (31.75)	1.250 (31.75)	1.250 (31.75)	1.500 (38.10)	1.500 (38.10)	1.500 (38.10)
KK	Std.	7/16 - 20	7/16 - 20	7/16 - 20	3/4 - 16	3/4 - 16	3/4 - 16	1 - 14	1 - 14	1 - 14
	O.S.	3/4 - 16	3/4 - 16	3/4 - 16	1 - 14	1 - 14	1 - 14	1-1/4 - 12	1-1/4 - 12	1-1/4 - 12
LB		3.625 (92.08)	3.625 (92.08)	3.750 (95.25)	4.250 (107.95)	4.250 (107.95)	4.500 (114.30)	5.000 (127.00)	5.125 (130.18)	5.125 (130.18)
MM	Std.	.625 (15.88)	.625 (15.88)	.625 (15.88)	1.000 (25.40)	1.000 (25.40)	1.000 (25.40)	1.375 (34.93)	1.375 (34.93)	1.375 (34.93)
	O.S.	1.000 (25.40)	1.000 (25.40)	1.000 (25.40)	1.375 (34.93)	1.375 (34.93)	1.375 (34.93)	1.750 (44.45)	1.750 (44.45)	1.750 (44.45)
P		2.313 (58.74)	2.313 (58.74)	2.438 (61.91)	2.625 (66.68)	2.625 (66.68)	2.875 (73.03)	3.125 (79.38)	3.250 (82.55)	3.250 (82.55)
R		1.428 (36.27)	1.838 (46.68)	2.192 (55.67)	2.758 (70.05)	3.323 (84.40)	4.101 (104.16)	4.879 (123.92)	5.639 (145.54)	6.442 (163.63)
SE		5.500 (139.70)	5.875 (149.23)	6.250 (158.75)	6.625 (168.28)	6.875 (174.63)	7.250 (184.15)	7.750 (196.85)	8.000 (203.20)	8.000 (203.20)
VF	Std.	.625 (15.88)	.625 (15.88)	.625 (15.88)	.875 (22.23)	.875 (22.23)	.875 (22.23)	1.000 (25.40)	1.000 (25.40)	1.000 (25.40)
	O.S.	.875 (22.23)	.875 (22.23)	.875 (22.23)	1.000 (25.40)	1.000 (25.40)	1.000 (25.40)	1.125 (28.58)	1.125 (28.58)	1.125 (28.58)
WF	Std.	1.000 (25.40)	1.000 (25.40)	1.000 (25.40)	1.375 (34.93)	1.375 (34.93)	1.375 (34.93)	1.625 (41.28)	1.625 (41.28)	1.625 (41.28)
	O.S.	1.375 (34.93)	1.375 (34.93)	1.375 (34.93)	1.625 (41.28)	1.625 (41.28)	1.625 (41.28)	1.875 (47.63)	1.875 (47.63)	1.875 (47.63)
XE	Std.	5.375 (136.53)	5.563 (141.29)	5.813 (147.64)	6.500 (165.10)	6.625 (168.28)	6.938 (176.21)	7.625 (193.68)	7.875 (200.03)	7.875 (200.03)
	O.S.	5.750 (146.05)	5.938 (150.81)	6.188 (157.16)	6.750 (171.45)	6.875 (174.63)	7.188 (182.56)	7.875 (200.03)	8.125 (206.38)	8.125 (206.38)
Y	Std.	1.875 (47.63)	1.875 (47.63)	1.875 (47.63)	2.438 (61.91)	2.438 (61.91)	2.438 (61.91)	2.813 (71.44)	2.813 (71.44)	2.813 (71.44)
	O.S.	2.250 (57.15)	2.250 (57.15)	2.250 (57.15)	2.688 (68.26)	2.688 (68.26)	2.688 (68.26)	3.063 (77.79)	3.063 (77.79)	3.063 (77.79)
ZE	Std.	5.625 (142.88)	5.875 (149.23)	6.125 (155.58)	6.875 (174.63)	7.000 (177.80)	7.438 (188.91)	8.125 (206.38)	8.500 (215.90)	8.500 (215.90)
	O.S.	6.000 (152.40)	6.250 (158.75)	6.500 (165.10)	7.125 (180.98)	7.250 (184.15)	7.688 (195.26)	8.375 (212.73)	8.750 (222.25)	8.750 (222.25)

All dimensions in inches (mm)

Code 07 Head Rectangular Flange Mounts (ANSI MF1)

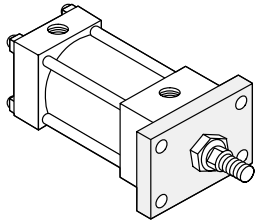

These mounts are ideal for straight line force transfer applications in which the cylinder is used in tension (pulling). The mounting surface should be flat and the rod end cartridge should be piloted into it.

The frame on which the cylinder is mounted must be sufficiently rigid to resist bending moments.

NOTE

For strokes in excess of 30 inches, see "Stop Tube Selection" on page 45.

The force of the load should be perpendicular to the mounting surface and parallel to the centerline of the piston rod. For eccentric loads, the larger of the two available rods in each bore size is recommended. Stop tubes should also be considered.

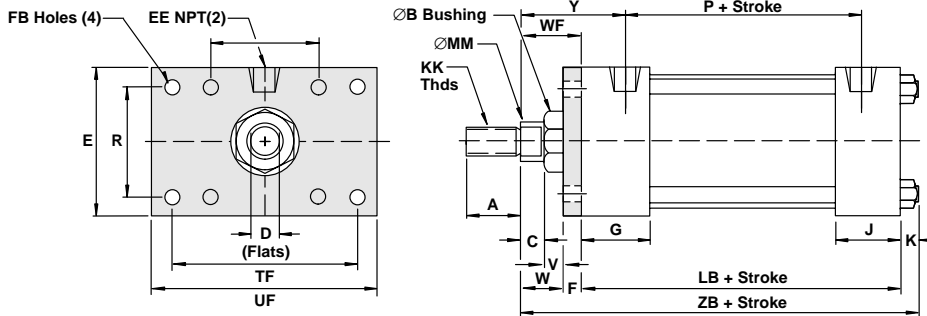

Dimension		1 1/2" Bore (38.10)	2" Bore (50.80)	2 1/2" Bore (63.50)	3 1/4" Bore (82.55)	4" Bore (101.60)	5" Bore (127.00)	6" Bore (152.40)
Ø Rod	Std.	5/8" (15.88)	5/8" (15.88)	5/8" (15.88)	1" (25.40)	1" (25.40)	1" (25.40)	1-3/8" (34.93)
	O.S.	1" (25.40)	1" (25.40)	1" (25.40)	1-3/8" (34.93)	1-3/8" (34.93)	1-3/8" (34.93)	1-3/4" (44.45)
A	Std.	.750 (19.05)	.750 (19.05)	.750 (19.05)	1.125 (28.58)	1.125 (28.58)	1.125 (28.58)	1.625 (41.28)
	O.S.	1.125 (28.58)	1.125 (28.58)	1.125 (28.58)	1.625 (41.28)	1.625 (41.28)	1.625 (41.28)	2.000 (50.80)
B _{+0.000} _{-0.002}	Std.	1.124 (28.55)	.750 (19.05)	.750 (19.05)	1.125 (28.58)	1.125 (28.58)	1.125 (28.58)	1.625 (41.28)
	O.S.	1.499 (38.08)	1.125 (28.58)	1.125 (28.58)	1.625 (41.28)	1.625 (41.28)	1.625 (41.28)	2.000 (50.80)
C	Std.	.375 (9.53)	.375 (9.53)	.375 (9.53)	.500 (12.70)	.500 (12.70)	.500 (12.70)	.625 (15.88)
	O.S.	.500 (12.70)	.500 (12.70)	.500 (12.70)	.625 (15.88)	.625 (15.88)	.625 (15.88)	.750 (19.05)
CC	Std.	1/2 - 20	1/2 - 20	1/2 - 20	7/8 - 14	7/8 - 14	7/8 - 14	1-1/4 - 12
	O.S.	7/8 - 14	7/8 - 14	7/8 - 14	1-1/4 - 12	1-1/4 - 12	1-1/4 - 12	1-1/2 - 12
D	Std.	.500 (12.70)	.500 (12.70)	.500 (12.70)	.813 (20.64)	.813 (20.64)	.813 (20.64)	1.125 (28.58)
	O.S.	.813 (20.64)	.813 (20.64)	.813 (20.64)	1.125 (28.58)	1.125 (28.58)	1.125 (28.58)	1.500 (38.10)
E		2.000 (50.80)	2.500 (63.50)	3.000 (76.20)	3.750 (95.25)	4.500 (114.30)	5.500 (139.70)	6.500 (165.10)
EE		.375 (9.53)	.375 (9.53)	.375 (9.53)	.500 (12.70)	.500 (12.70)	.500 (12.70)	.750 (19.05)
F		.375 (9.53)	.375 (9.53)	.375 (9.53)	.500 (12.70)	.500 (12.70)	.500 (12.70)	.750 (19.05)
FB		.375 (9.53)	.375 (9.53)	.375 (9.53)	.500 (12.70)	.500 (12.70)	.500 (12.70)	.750 (19.05)
FF	Std.	5/8 - 18	5/8 - 18	5/8 - 18	1 - 14	1 - 14	1 - 14	1-3/8 - 12
	O.S.	1 - 14	1 - 14	1 - 14	1-3/8 - 12	1-3/8 - 12	1-3/8 - 12	1-3/4 - 12
G		1.500 (38.10)	1.500 (38.10)	1.500 (38.10)	1.750 (44.45)	1.750 (44.45)	1.750 (44.45)	2.000 (50.80)
J		1.000 (25.40)	1.000 (25.40)	1.000 (25.40)	1.250 (31.75)	1.250 (31.75)	1.250 (31.75)	1.500 (38.10)
K		.250 (6.35)	.313 (7.94)	.313 (7.94)	.375 (9.53)	.438 (11.11)	.438 (11.11)	1.500 (38.10)
KK	Std.	7/16 - 20	7/16 - 20	7/16 - 20	3/4 - 16	3/4 - 16	3/4 - 16	1 - 14
	O.S.	3/4 - 16	3/4 - 16	3/4 - 16	1 - 14	1 - 14	1 - 14	1-1/4 - 12
LB		3.625 (92.08)	3.625 (92.08)	3.750 (95.25)	4.250 (107.95)	4.250 (107.95)	4.500 (114.30)	5.000 (127.00)
MM	Std.	.625 (15.88)	.625 (15.88)	.625 (15.88)	1.000 (25.40)	1.000 (25.40)	1.000 (25.40)	1.375 (34.93)
	O.S.	1.000 (25.40)	1.000 (25.40)	1.000 (25.40)	1.375 (34.93)	1.375 (34.93)	1.375 (34.93)	1.750 (44.45)
P		2.313 (58.74)	2.313 (58.74)	2.438 (61.91)	2.625 (66.68)	2.625 (66.68)	2.875 (73.03)	3.125 (79.38)
R		1.428 (36.27)	1.838 (46.68)	2.192 (55.67)	2.758 (70.05)	3.323 (84.40)	4.101 (104.16)	4.879 (123.92)
TF		2.750 (69.85)	3.375 (85.73)	3.875 (98.43)	4.688 (119.06)	5.438 (138.11)	6.625 (168.28)	7.625 (193.68)
UF		3.375 (85.73)	4.125 (104.78)	4.625 (117.48)	5.500 (139.70)	6.250 (158.75)	7.625 (193.68)	8.625 (219.08)
V	Std.	.250 (6.35)	.250 (6.35)	.250 (6.35)	.250 (6.35)	.250 (6.35)	.250 (6.35)	.250 (6.35)
	O.S.	.500 (12.70)	.500 (12.70)	.500 (12.70)	.375 (9.53)	.375 (9.53)	.375 (9.53)	.375 (9.53)
W	Std.	.625 (15.88)	.625 (15.88)	.625 (15.88)	.750 (19.05)	.750 (19.05)	.750 (19.05)	.875 (22.23)
	O.S.	1.000 (25.40)	1.000 (25.40)	1.000 (25.40)	1.000 (25.40)	1.000 (25.40)	1.000 (25.40)	1.125 (28.58)
WF	Std.	1.000 (25.40)	1.000 (25.40)	1.000 (25.40)	1.375 (34.93)	1.375 (34.93)	1.375 (34.93)	1.625 (41.28)
	O.S.	1.375 (34.93)	1.375 (34.93)	1.375 (34.93)	1.625 (41.28)	1.625 (41.28)	1.625 (41.28)	1.875 (47.63)
Y	Std.	1.875 (47.63)	1.875 (47.63)	1.875 (47.63)	2.438 (61.91)	2.438 (61.91)	2.438 (61.91)	2.813 (71.44)
	O.S.	2.250 (57.15)	2.250 (57.15)	2.250 (57.15)	2.688 (68.26)	2.688 (68.26)	2.688 (68.26)	3.063 (77.79)
ZB	Std.	4.875 (123.83)	4.938 (125.41)	5.063 (128.59)	6.000 (152.40)	6.000 (152.40)	6.313 (160.34)	7.063 (179.39)
	O.S.	5.250 (133.35)	5.313 (134.94)	5.438 (138.11)	6.250 (158.75)	6.250 (158.75)	6.563 (166.69)	7.313 (185.74)

All dimensions in inches (mm)

Code 08 Head Square Mounts (ANSI ME3)

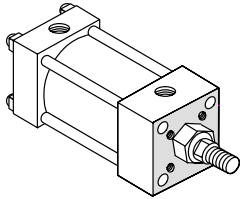

These mounts are ideal for straight line force transfer applications in which the cylinder is used in tension (pulling). The mounting surface should be flat, and the rod end cartridge should be piloted into it.

The frame on which the cylinder is mounted must be sufficiently rigid to resist bending moments.

NOTE

For strokes in excess of 30 inches, see "Stop Tube Selection" on page 45.

The force of the load should be perpendicular to the mounting surface and parallel to the centerline of the piston rod. For eccentric loads, the larger of the two available rods in each bore size is recommended. Stop tubes should also be considered.

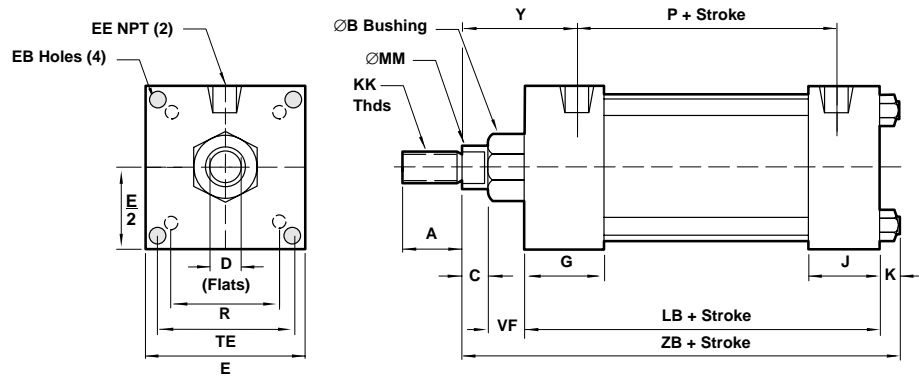

Dimension	7" Bore (177.80)	8" Bore (203.20)
Ø Rod	Std. 1-3/8" (34.93)	1-3/8" (34.93)
	O.S. 1-3/4" (44.45)	1-3/4" (44.45)
A	Std. 1.625 (41.28)	1.625 (41.28)
	O.S. 2.000 (50.80)	2.000 (50.80)
B ^{+0.000} _{-0.002}	Std. 1.625 (41.28)	1.625 (41.28)
	O.S. 2.000 (50.80)	2.000 (50.80)
C	Std. .625 (15.88)	.625 (15.88)
	O.S. .750 (19.05)	.750 (19.05)
CC	Std. 1-1/4 - 12	1-1/4 - 12
	O.S. 1-1/2 - 12	1-1/2 - 12
D	Std. 1.125 (15.88)	1.125 (15.88)
	O.S. 1.500 (38.10)	1.500 (38.10)
E	7.500 (190.50)	8.500 (215.90)
EB	.688 (17.46)	.688 (17.46)
EE	.750 (19.05)	.750 (19.05)
FF	Std. 1-3/8 - 12	1-3/8 - 12
	O.S. 1-3/4 - 12	1-3/4 - 12
G	2.000 (50.80)	2.000 (50.80)
J	1.500 (38.10)	1.500 (38.10)
K	.563 (14.29)	.563 (14.29)
KK	Std. 1 - 14	1 - 14
	O.S. 1-1/4 - 12	1-1/4 - 12
LB	5.125 (130.18)	5.125 (130.18)
MM	Std. 1.375 (34.93)	1.375 (34.93)
	O.S. 1.750 (44.45)	1.750 (44.45)
P	3.250 (82.55)	3.250 (82.55)
R	5.639 (145.54)	6.442 (163.63)
TE	6.750 (171.45)	7.570 (192.27)
VF	Std. 1.000 (25.40)	1.000 (25.40)
	O.S. 1.125 (28.58)	1.125 (28.58)
Y	Std. 2.813 (71.44)	2.813 (71.44)
	O.S. 3.063 (77.79)	3.063 (77.79)
ZB	Std. 7.313 (185.74)	7.313 (185.74)
	O.S. 7.563 (192.09)	7.563 (192.09)

All dimensions in inches (mm)

Code 10 Fixed Clevis (MP1)

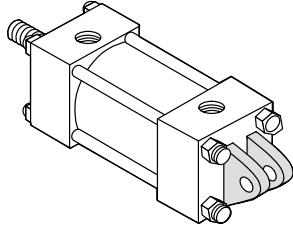

These mounts can be used both in compression (push) and tension (pull). Care must be exercised to prevent rod buckling in compression applications with long strokes.

NOTE

For strokes in excess of 30 inches, see "Stop Tube Selection" on page 45.

The centerline of the machine member that attaches to the swivel pin must be perpendicular to the centerline of the piston rod and the curved path must be in one place only. Any misalignment will cause excess side loading on the bearing and piston. This could lead to premature failure.

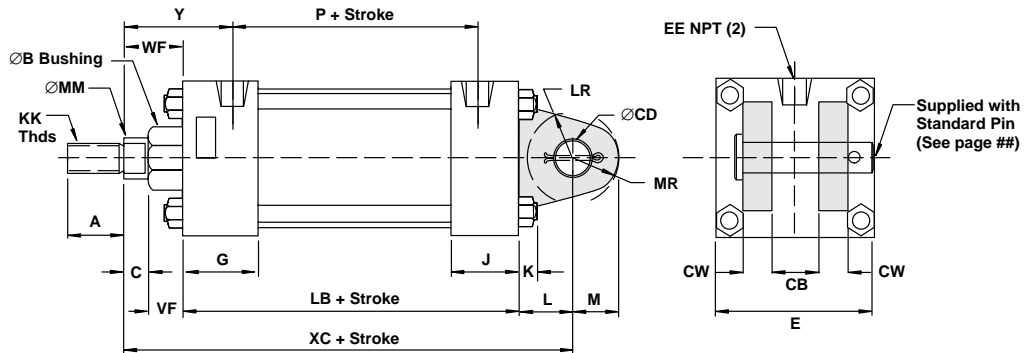

Dimension	1 1/2" Bore (38.10)	2" Bore (50.80)	2 1/2" Bore (63.50)	3 1/4" Bore (82.55)	4" Bore (101.60)	5" Bore (127.00)	6" Bore (152.40)	7" Bore (177.80)	8" Bore (203.20)
øRod	Std. 5/8" (15.88)	5/8" (15.88)	5/8" (15.88)	1" (25.40)	1" (25.40)	1" (25.40)	1-3/8" (34.93)	1-3/8" (34.93)	1-3/8" (34.93)
	O.S. 1" (25.40)	1" (25.40)	1" (25.40)	1-3/8" (34.93)	1-3/8" (34.93)	1-3/8" (34.93)	1-3/4" (44.45)	1-3/4" (44.45)	1-3/4" (44.45)
A	Std. .750 (19.05)	.750 (19.05)	.750 (19.05)	1.125 (28.58)	1.125 (28.58)	1.125 (28.58)	1.625 (41.28)	1.625 (41.28)	1.625 (41.28)
	O.S. 1.125 (28.58)	1.125 (28.58)	1.125 (28.58)	1.625 (41.28)	1.625 (41.28)	1.625 (41.28)	2.000 (50.80)	2.000 (50.80)	2.000 (50.80)
B ₋₀₀₂	Std. 1.124 (28.55)	1.124 (28.55)	1.124 (28.55)	1.499 (38.08)	1.499 (38.08)	1.499 (38.08)	1.999 (50.78)	1.999 (50.78)	1.999 (50.78)
	O.S. 1.499 (38.08)	1.499 (38.08)	1.499 (38.08)	1.999 (50.78)	1.999 (50.78)	1.999 (50.78)	2.374 (60.30)	2.374 (60.30)	2.374 (60.30)
C	Std. .375 (9.53)	.375 (9.53)	.375 (9.53)	.500 (12.70)	.500 (12.70)	.500 (12.70)	.625 (15.88)	.625 (15.88)	.625 (15.88)
	O.S. .500 (12.70)	.500 (12.70)	.500 (12.70)	.625 (15.88)	.625 (15.88)	.625 (15.88)	.750 (19.05)	.750 (19.05)	.750 (19.05)
CB	.750 (19.05)	.750 (19.05)	.750 (19.05)	1.250 (31.75)	1.250 (31.75)	1.250 (31.75)	1.500 (38.10)	1.500 (38.10)	1.500 (38.10)
CC	Std. 1/2 - 20	1/2 - 20	1/2 - 20	7/8 - 14	7/8 - 14	7/8 - 14	1-1/4 - 12	1-1/4 - 12	1-1/4 - 12
	O.S. 7/8 - 14	7/8 - 14	7/8 - 14	1-1/4 - 12	1-1/4 - 12	1-1/4 - 12	1-1/2 - 12	1-1/2 - 12	1-1/2 - 12
CD	.500 (12.70)	.500 (12.70)	.500 (12.70)	.750 (19.05)	.750 (19.05)	.750 (19.05)	1.000 (25.40)	1.000 (25.40)	1.000 (25.40)
CW	.500 (12.70)	.500 (12.70)	.500 (12.70)	.625 (15.88)	.625 (15.88)	.625 (15.88)	.750 (19.05)	.750 (19.05)	.750 (19.05)
D	Std. .500 (12.70)	.500 (12.70)	.500 (12.70)	.813 (20.64)	.813 (20.64)	.813 (20.64)	1.125 (28.58)	1.125 (28.58)	1.125 (28.58)
	O.S. .813 (20.64)	.813 (20.64)	.813 (20.64)	1.125 (28.58)	1.125 (28.58)	1.125 (28.58)	1.500 (38.10)	1.500 (38.10)	1.500 (38.10)
E	2.000 (50.80)	2.500 (63.50)	3.000 (76.20)	3.750 (95.25)	4.500 (114.30)	5.500 (139.70)	6.500 (165.10)	7.500 (190.50)	8.500 (215.90)
EE	.375 (9.53)	.375 (9.53)	.375 (9.53)	.500 (12.70)	.500 (12.70)	.500 (12.70)	.750 (19.05)	.750 (19.05)	.750 (19.05)
FF	Std. 5/8 - 18	5/8 - 18	5/8 - 18	1 - 14	1 - 14	1 - 14	1-3/8 - 12	1-3/8 - 12	1-3/8 - 12
	O.S. 1 - 14	1 - 14	1 - 14	1-3/8 - 12	1-3/8 - 12	1-3/8 - 12	1-3/4 - 12	1-3/4 - 12	1-3/4 - 12
G	1.500 (38.10)	1.500 (38.10)	1.500 (38.10)	1.750 (44.45)	1.750 (44.45)	1.750 (44.45)	2.000 (50.80)	2.000 (50.80)	2.000 (50.80)
J	1.000 (25.40)	1.000 (25.40)	1.000 (25.40)	1.250 (31.75)	1.250 (31.75)	1.250 (31.75)	1.500 (38.10)	1.500 (38.10)	1.500 (38.10)
KK	Std. 7/16 - 20	7/16 - 20	7/16 - 20	3/4 - 16	3/4 - 16	3/4 - 16	1 - 14	1 - 14	1 - 14
	O.S. 3/4 - 16	3/4 - 16	3/4 - 16	1 - 14	1 - 14	1 - 14	1-1/4 - 12	1-1/4 - 12	1-1/4 - 12
L	.750 (19.05)	.750 (19.05)	.750 (19.05)	1.250 (31.75)	1.250 (31.75)	1.250 (31.75)	1.500 (38.10)	1.500 (38.10)	1.500 (38.10)
LB	3.625 (92.08)	3.625 (92.08)	3.750 (95.25)	4.250 (107.95)	4.250 (107.95)	4.500 (114.30)	5.000 (127.00)	5.125 (130.18)	5.125 (130.18)
LR	.750 (19.05)	.750 (19.05)	.750 (19.05)	1.250 (31.75)	1.250 (31.75)	1.250 (31.75)	1.500 (38.10)	1.500 (38.10)	1.500 (38.10)
M	.500 (12.70)	.500 (12.70)	.500 (12.70)	.750 (19.05)	.750 (19.05)	.750 (19.05)	1.000 (25.40)	1.000 (25.40)	1.000 (25.40)
MM	Std. .625 (15.88)	.625 (15.88)	.625 (15.88)	1.000 (25.40)	1.000 (25.40)	1.000 (25.40)	1.375 (34.93)	1.375 (34.93)	1.375 (34.93)
	O.S. 1.000 (25.40)	1.000 (25.40)	1.000 (25.40)	1.375 (34.93)	1.375 (34.93)	1.375 (34.93)	1.750 (44.45)	1.750 (44.45)	1.750 (44.45)
MR	.625 (15.88)	.625 (15.88)	.625 (15.88)	.938 (23.81)	.938 (23.81)	.938 (23.81)	1.188 (30.16)	1.188 (30.16)	1.188 (30.16)
P	2.313 (58.74)	2.313 (58.74)	2.438 (61.91)	2.625 (66.68)	2.625 (66.68)	2.875 (73.03)	3.125 (79.38)	3.250 (82.55)	3.250 (82.55)
VF	Std. .625 (15.88)	.625 (15.88)	.625 (15.88)	.875 (22.23)	.875 (22.23)	.875 (22.23)	1.000 (25.40)	1.000 (25.40)	1.000 (25.40)
	O.S. .875 (22.23)	.875 (22.23)	.875 (22.23)	1.000 (25.40)	1.000 (25.40)	1.000 (25.40)	1.125 (28.58)	1.125 (28.58)	1.125 (28.58)
WF	Std. 1.000 (25.40)	1.000 (25.40)	1.000 (25.40)	1.375 (34.93)	1.375 (34.93)	1.375 (34.93)	1.625 (41.28)	1.625 (41.28)	1.625 (41.28)
	O.S. 1.375 (34.93)	1.375 (34.93)	1.375 (34.93)	1.625 (41.28)	1.625 (41.28)	1.625 (41.28)	1.875 (47.63)	1.875 (47.63)	1.875 (47.63)
XC	Std. 5.375 (136.53)	5.375 (136.53)	5.500 (139.70)	6.875 (174.63)	6.875 (174.63)	7.125 (180.98)	8.125 (206.38)	8.250 (209.55)	8.250 (209.55)
	O.S. 5.750 (146.05)	5.750 (146.05)	5.875 (149.23)	7.125 (180.98)	7.125 (180.98)	7.375 (187.33)	8.375 (212.73)	8.500 (215.90)	8.500 (215.90)
Y	Std. 1.875 (47.63)	1.875 (47.63)	1.875 (47.63)	2.438 (61.91)	2.438 (61.91)	2.438 (61.91)	2.813 (71.44)	2.813 (71.44)	2.813 (71.44)
	O.S. 2.250 (57.15)	2.250 (57.15)	2.250 (57.15)	2.688 (68.26)	2.688 (68.26)	2.688 (68.26)	3.063 (77.79)	3.063 (77.79)	3.063 (77.79)

All dimensions in inches (mm)

Code 12 Cap Rectangular Flange Mounts (ANSI MF2)

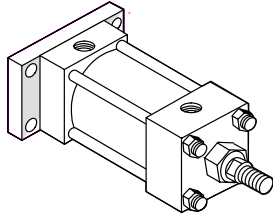

These mounts are ideal for straight line force transfer applications in which the cylinder is used in compression (pushing), as in push presses. For tension applications (pulling), a head rectangular mount is more appropriate.

The frame on which the cylinder is mounted must be sufficiently rigid to resist bending moments.

NOTE

For strokes in excess of 30 inches, see "Stop Tube Selection" on page 45.

Cap rectangular mounts are recommended for heavy duty applications.

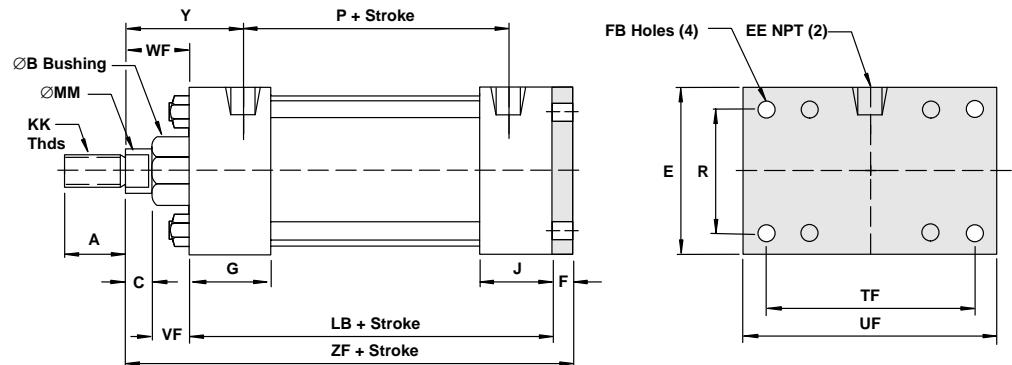

Dimension		1½" Bor (38.10)	2" Bore (50.80)	2½" Bore (63.50)	3¼" Bore (82.55)	4" Bore (101.60)	5" Bore (127.00)	6" Bore (152.40)
ØRod	Std.	5/8" (15.88)	5/8" (15.88)	5/8" (15.88)	1" (25.40)	1" (25.40)	1" (25.40)	1-3/8" (34.93)
	O.S.	1" (25.40)	1" (25.40)	1" (25.40)	1-3/8" (34.93)	1-3/8" (34.93)	1-3/8" (34.93)	1-3/4" (44.45)
A	Std.	.750 (19.05)	.750 (19.05)	.750 (19.05)	1.125 (28.58)	1.125 (28.58)	1.125 (28.58)	1.625 (41.28)
	O.S.	1.125 (28.58)	1.125 (28.58)	1.125 (28.58)	1.625 (41.28)	1.625 (41.28)	1.625 (41.28)	2.000 (50.80)
B ^{+0.000} _{-0.002}	Std.	1.124 (28.55)	1.124 (28.55)	1.124 (28.55)	1.499 (38.08)	1.499 (38.08)	1.499 (38.08)	1.999 (50.78)
	O.S.	1.499 (38.08)	1.499 (38.08)	1.499 (38.08)	1.999 (50.78)	1.999 (50.78)	1.999 (50.78)	2.374 (60.30)
C	Std.	.375 (9.53)	.375 (9.53)	.375 (9.53)	.500 (12.70)	.500 (12.70)	.500 (12.70)	.625 (15.88)
	O.S.	.500 (12.70)	.500 (12.70)	.500 (12.70)	.625 (15.88)	.625 (15.88)	.625 (15.88)	.750 (19.05)
CB		.750 (19.05)	.750 (19.05)	.750 (19.05)	1.250 (31.75)	1.250 (31.75)	1.250 (31.75)	1.500 (38.10)
CC	Std.	1/2 - 20	1/2 - 20	1/2 - 20	7/8 - 14	7/8 - 14	7/8 - 14	1-1/4 - 12
	O.S.	7/8 - 14	7/8 - 14	7/8 - 14	1-1/4 - 12	1-1/4 - 12	1-1/4 - 12	1-1/2 - 12
D	Std.	.500 (12.70)	.500 (12.70)	.500 (12.70)	.813 (20.64)	.813 (20.64)	.813 (20.64)	1.125 (28.58)
	O.S.	.813 (20.64)	.813 (20.64)	.813 (20.64)	1.125 (28.58)	1.125 (28.58)	1.125 (28.58)	1.500 (38.10)
E		2.000 (50.80)	2.500 (63.50)	3.000 (76.20)	3.750 (95.25)	4.500 (114.30)	5.500 (139.70)	6.500 (165.10)
EE		.375 (9.53)	.375 (9.53)	.375 (9.53)	.500 (12.70)	.500 (12.70)	.500 (12.70)	.750 (19.05)
F		.375 (9.53)	.375 (9.53)	.375 (9.53)	.625 (15.88)	.625 (15.88)	.625 (15.88)	.750 (19.05)
FB		.313 (7.94)	.375 (9.53)	.375 (9.53)	.438 (11.11)	.438 (11.11)	.563 (14.29)	.563 (14.29)
FF	Std.	5/8 - 18	5/8 - 18	5/8 - 18	1 - 14	1 - 14	1 - 14	1-3/8 - 12
	O.S.	1 - 14	1 - 14	1 - 14	1-3/8 - 12	1-3/8 - 12	1-3/8 - 12	1-3/4 - 12
G		1.500 (38.10)	1.500 (38.10)	1.500 (38.10)	1.750 (44.45)	1.750 (44.45)	1.750 (44.45)	2.000 (50.80)
J		1.000 (25.40)	1.000 (25.40)	1.000 (25.40)	1.250 (31.75)	1.250 (31.75)	1.250 (31.75)	1.500 (38.10)
K		.250 (6.35)	.313 (7.94)	.313 (7.94)	.375 (9.53)	.375 (9.53)	.438 (11.11)	.438 (11.11)
KK	Std.	7/16 - 20	7/16 - 20	7/16 - 20	3/4 - 16	3/4 - 16	3/4 - 16	1 - 14
	O.S.	3/4 - 16	3/4 - 16	3/4 - 16	1 - 14	1 - 14	1 - 14	1-1/4 - 12
LB		3.625 (92.08)	3.625 (92.08)	3.750 (95.25)	4.250 (107.95)	4.250 (107.95)	4.500 (114.30)	5.000 (127.00)
MM	Std.	.625 (15.88)	.625 (15.88)	.625 (15.88)	1.000 (25.40)	1.000 (25.40)	1.000 (25.40)	1.375 (34.93)
	O.S.	1.000 (25.40)	1.000 (25.40)	1.000 (25.40)	1.375 (34.93)	1.375 (34.93)	1.375 (34.93)	1.750 (44.45)
P		2.313 (58.74)	2.313 (58.74)	2.438 (61.91)	2.625 (66.68)	2.625 (66.68)	2.875 (73.03)	3.125 (79.38)
R		1.428 (36.27)	1.838 (46.68)	2.192 (55.67)	2.758 (70.05)	3.323 (84.40)	4.101 (104.16)	4.879 (123.93)
TF		2.750 (69.85)	3.375 (85.73)	3.875 (98.43)	4.687 (119.05)	5.438 (138.11)	6.625 (168.28)	7.625 (193.68)
UF		3.375 (85.73)	4.125 (104.78)	4.625 (117.48)	5.500 (139.70)	6.250 (158.75)	7.625 (193.68)	8.625 (219.08)
VF	Std.	.625 (15.88)	.625 (15.88)	.625 (15.88)	.875 (22.23)	.875 (22.23)	.875 (22.23)	1.000 (25.40)
	O.S.	.875 (22.23)	.875 (22.23)	.875 (22.23)	1.000 (25.40)	1.000 (25.40)	1.000 (25.40)	1.125 (28.58)
WF	Std.	1.000 (25.40)	1.000 (25.40)	1.000 (25.40)	1.375 (34.93)	1.375 (34.93)	1.375 (34.93)	1.625 (41.28)
	O.S.	1.375 (34.93)	1.375 (34.93)	1.375 (34.93)	1.625 (41.28)	1.625 (41.28)	1.625 (41.28)	1.875 (47.63)
Y	Std.	1.875 (47.63)	1.875 (47.63)	1.875 (47.63)	2.438 (61.91)	2.438 (61.91)	2.438 (61.91)	2.813 (71.44)
	O.S.	2.250 (57.15)	2.250 (57.15)	2.250 (57.15)	2.688 (68.26)	2.688 (68.26)	2.688 (68.26)	3.063 (77.79)
ZF	Std.	5.000 (127.00)	5.000 (127.00)	5.125 (130.18)	6.250 (158.75)	6.250 (158.75)	6.500 (165.10)	7.375 (187.33)
	O.S.	5.375 (136.53)	5.375 (136.53)	5.500 (139.70)	6.500 (165.10)	6.500 (165.10)	6.750 (171.45)	7.625 (193.68)

All dimensions in inches (mm)

Code 13 Cap Square Mounts (ANSI ME4)

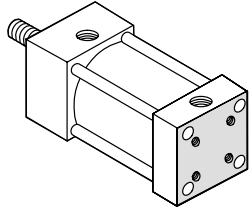

These mounts are ideal for straight line force transfer applications in which the cylinder is used in compression (pushing). The mounting surface should be flat and the rod end cartridge should be piloted into it.

The frame on which the cylinder is mounted must be sufficiently rigid to resist bending moments.

NOTE

For strokes in excess of 30 inches, see "Stop Tube Selection" on page 45.

The force of the load should be perpendicular to the mounting surface and parallel to the centerline of the piston rod. For eccentric loads, the larger of the two available rods in each bore size is recommended. Stop tubes should also be considered.

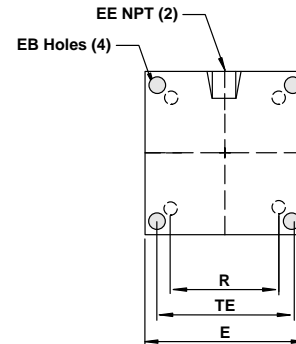
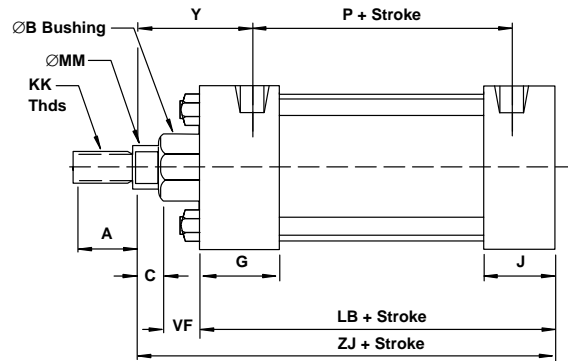

Dimension	7" Bore (177.80)	8" Bore (203.20)
∅Rod	Std. 1-3/8" (34.93)	1-3/8" (34.93)
	O.S. 1-3/4" (44.45)	1-3/4" (44.45)
A	Std. 1.625 (41.28)	1.625 (41.28)
	O.S. 2.000 (50.80)	2.000 (50.80)
B ^{+0.001} _{-0.002}	Std. 1.625 (41.28)	1.625 (41.28)
	O.S. 2.000 (50.80)	2.000 (50.80)
C	Std. .625 (15.88)	.625 (15.88)
	O.S. .750 (19.05)	.750 (19.05)
CC	Std. 1-1/4 - 12	1-1/4 - 12
	O.S. 1-1/2 - 12	1-1/2 - 12
D	Std. 1.125 (15.88)	1.125 (15.88)
	O.S. 1.500 (38.10)	1.500 (38.10)
E	7.500 (190.50)	8.500 (215.90)
EB	.688 (17.46)	.688 (17.46)
EE	.750 (19.05)	.750 (19.05)
FF	Std. 1-3/8 - 12	1-3/8 - 12
	O.S. 1-3/4 - 12	1-3/4 - 12
G	2.000 (50.80)	2.000 (50.80)
J	1.500 (38.10)	1.500 (38.10)
K	.563 (14.29)	.563 (14.29)
KK	Std. 1 - 14	1 - 14
	O.S. 1-1/4 - 12	1-1/4 - 12
LB	5.125 (130.18)	5.125 (130.18)
MM	Std. 1.375 (34.93)	1.375 (34.93)
	O.S. 1.750 (44.45)	1.750 (44.45)
P	3.250 (82.55)	3.250 (82.55)
R	5.639 (145.54)	6.442 (163.63)
TE	6.750 (171.45)	7.570 (192.27)
VF	Std. 1.000 (25.40)	1.000 (25.40)
	O.S. 1.125 (28.58)	1.125 (28.58)
Y	Std. 2.813 (71.44)	2.813 (71.44)
	O.S. 3.063 (77.79)	3.063 (77.79)
ZB	Std. 7.313 (185.74)	7.313 (185.74)
	O.S. 7.563 (192.09)	7.563 (192.09)

All dimensions in inches (mm)

Code 16 Cap Trunnion Mounts (ANSI MT2)

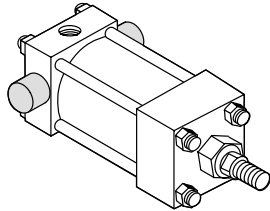

These mounts are for applications in which the machine member travels in a curved path in one plane.

The mount can be used both in compression (push) and tension (pull) applications. When used in compression applications, head trunnion mounts provide a longer maximum stroke than cap trunnion mounts.

NOTE

For strokes in excess of 30 inches, see "Stop tube selection" on page 45.

The frame on which the cylinder is mounted must be sufficiently rigid to resist bending moments.

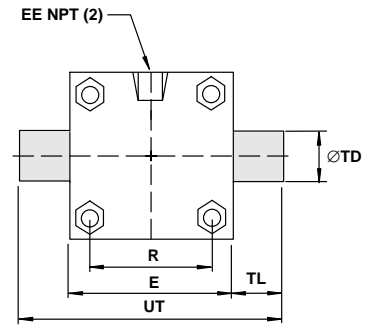
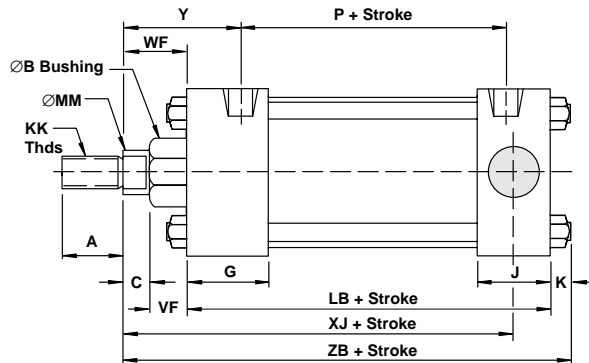

Dimension		1 1/2" Bore (38.10)	2" Bore (50.80)	2 1/2" Bore (63.50)	3 1/4" Bore (82.55)	4" Bore (101.60)	5" Bore (127.00)	6" Bore (152.40)	7" Bore (177.80)	8" Bore (203.20)
∅Rod	Std.	5/8" (15.88)	5/8" (15.88)	5/8" (15.88)	1" (25.40)	1" (25.40)	1" (25.40)	1-3/8" (34.93)	1-3/8" (34.93)	1-3/8" (34.93)
	O.S.	1" (25.40)	1" (25.40)	1" (25.40)	1-3/8" (34.93)	1-3/8" (34.93)	1-3/8" (34.93)	1-3/4" (44.45)	1-3/4" (44.45)	1-3/4" (44.45)
A	Std.	.750 (19.05)	.750 (19.05)	.750 (19.05)	1.125 (28.58)	1.125 (28.58)	1.125 (28.58)	1.625 (41.28)	1.625 (41.28)	1.625 (41.28)
	O.S.	1.125 (28.58)	1.125 (28.58)	1.125 (28.58)	1.625 (41.28)	1.625 (41.28)	1.625 (41.28)	2.000 (50.80)	2.000 (50.80)	2.000 (50.80)
B ^{+0.000} _{-0.002}	Std.	1.124 (28.55)	1.124 (28.55)	1.124 (28.55)	1.499 (38.08)	1.499 (38.08)	1.499 (38.08)	1.999 (50.78)	1.999 (50.78)	1.999 (50.78)
	O.S.	1.499 (38.08)	1.499 (38.08)	1.499 (38.08)	1.999 (50.78)	1.999 (50.78)	1.999 (50.78)	2.374 (60.30)	2.374 (60.30)	2.374 (60.30)
C	Std.	.375 (9.53)	.375 (9.53)	.375 (9.53)	.500 (12.70)	.500 (12.70)	.500 (12.70)	.625 (15.88)	.625 (15.88)	.625 (15.88)
	O.S.	.500 (12.70)	.500 (12.70)	.500 (12.70)	.625 (15.88)	.625 (15.88)	.625 (15.88)	.750 (19.05)	.750 (19.05)	.750 (19.05)
CC	Std.	1/2 - 20	1/2 - 20	1/2 - 20	7/8 - 14	7/8 - 14	7/8 - 14	1-1/4 - 12	1-1/4 - 12	1-1/4 - 12
	O.S.	7/8 - 14	7/8 - 14	7/8 - 14	1-1/4 - 12	1-1/4 - 12	1-1/4 - 12	1-1/2 - 12	1-1/2 - 12	1-1/2 - 12
D	Std.	.500 (12.70)	.500 (12.70)	.500 (12.70)	.875 (22.23)	.875 (22.23)	.875 (22.23)	1.125 (15.88)	1.125 (15.88)	1.125 (15.88)
	O.S.	.875 (22.23)	.875 (22.23)	.875 (22.23)	1.125 (28.58)	1.125 (28.58)	1.125 (28.58)	1.500 (38.10)	1.500 (38.10)	1.500 (38.10)
E		2.000 (50.80)	2.500 (63.50)	3.000 (76.20)	3.750 (95.25)	4.500 (114.30)	5.500 (139.70)	6.500 (165.10)	7.500 (190.50)	8.500 (215.90)
EE		.375 (9.53)	.375 (9.53)	.375 (9.53)	.500 (12.70)	.500 (12.70)	.500 (12.70)	.750 (19.05)	.750 (19.05)	.750 (19.05)
FF	Std.	5/8 - 18	5/8 - 18	5/8 - 18	1 - 14	1 - 14	1 - 14	1-3/8 - 12	1-3/8 - 12	1-3/8 - 12
	O.S.	1 - 14	1 - 14	1 - 14	1-3/8 - 12	1-3/8 - 12	1-3/8 - 12	1-3/4 - 12	1-3/4 - 12	1-3/4 - 12
G		1.500 (38.10)	1.500 (38.10)	1.500 (38.10)	1.750 (44.45)	1.750 (44.45)	1.750 (44.45)	2.000 (50.80)	2.000 (50.80)	2.000 (50.80)
J		1.000 (25.40)	1.000 (25.40)	1.000 (25.40)	1.250 (31.75)	1.250 (31.75)	1.250 (31.75)	1.500 (38.10)	1.500 (38.10)	1.500 (38.10)
K		.250 (6.35)	.313 (7.94)	.313 (7.94)	.375 (9.53)	.375 (9.53)	.438 (11.11)	.438 (11.11)	.563 (14.29)	.563 (14.29)
KK	Std.	7/16 - 20	7/16 - 20	7/16 - 20	3/4 - 16	3/4 - 16	3/4 - 16	1 - 14	1 - 14	1 - 14
	O.S.	3/4 - 16	3/4 - 16	3/4 - 16	1 - 14	1 - 14	1 - 14	1-1/4 - 12	1-1/4 - 12	1-1/4 - 12
LB		3.625 (92.08)	3.625 (92.08)	3.750 (95.25)	4.250 (107.95)	4.250 (107.95)	4.500 (114.30)	5.000 (127.00)	5.125 (130.18)	5.125 (130.18)
MM	Std.	.625 (15.88)	.625 (15.88)	.625 (15.88)	1.000 (25.40)	1.000 (25.40)	1.000 (25.40)	1.375 (34.93)	1.375 (34.93)	1.375 (34.93)
	O.S.	1.000 (25.40)	1.000 (25.40)	1.000 (25.40)	1.375 (34.93)	1.375 (34.93)	1.375 (34.93)	1.750 (44.45)	1.750 (44.45)	1.750 (44.45)
P		2.313 (58.74)	2.313 (58.74)	2.438 (61.91)	2.625 (66.68)	2.625 (66.68)	2.875 (73.03)	3.125 (79.38)	3.250 (82.55)	3.250 (82.55)
R		1.428 (36.27)	1.838 (46.68)	2.192 (55.67)	2.758 (70.05)	3.323 (84.40)	4.101 (104.16)	4.879 (123.92)	5.730 (145.54)	6.435 (163.44)
TD ^{+0.000} _{-0.001}		1.000 (25.40)	1.000 (25.40)	1.000 (25.40)	1.000 (25.40)	1.000 (25.40)	1.000 (25.40)	1.375 (34.93)	1.375 (34.93)	1.375 (34.93)
TL		1.000 (25.40)	1.000 (25.40)	1.000 (25.40)	1.000 (25.40)	1.000 (25.40)	1.000 (25.40)	1.375 (34.93)	1.375 (34.93)	1.375 (34.93)
UT		4.000 (101.60)	4.500 (114.30)	5.000 (127.00)	5.750 (146.05)	6.500 (165.10)	7.500 (190.50)	9.250 (234.95)	10.250 (260.35)	11.250 (285.75)
VF	Std.	.625 (15.88)	.625 (15.88)	.625 (15.88)	.875 (22.23)	.875 (22.23)	.875 (22.23)	1.000 (25.40)	1.000 (25.40)	1.000 (25.40)
	O.S.	.875 (22.23)	.875 (22.23)	.875 (22.23)	1.000 (25.40)	1.000 (25.40)	1.000 (25.40)	1.125 (28.58)	1.125 (28.58)	1.125 (28.58)
WF	Std.	1.000 (25.40)	1.000 (25.40)	1.000 (25.40)	1.375 (34.93)	1.375 (34.93)	1.375 (34.93)	1.625 (41.28)	1.625 (41.28)	1.625 (41.28)
	O.S.	1.375 (34.93)	1.375 (34.93)	1.375 (34.93)	1.625 (41.28)	1.625 (41.28)	1.625 (41.28)	1.875 (47.63)	1.875 (47.63)	1.875 (47.63)
XJ	Std.	4.125 (104.78)	4.125 (104.78)	4.250 (107.95)	5.000 (127.00)	5.250 (133.35)	5.500 (139.70)	6.125 (155.58)	6.250 (158.75)	6.250 (158.75)
	O.S.	5.750 (146.05)	5.750 (146.05)	5.875 (149.23)	7.125 (180.98)	7.125 (180.98)	7.375 (187.33)	8.375 (212.73)	8.500 (215.90)	8.500 (215.90)
Y	Std.	1.875 (47.63)	1.875 (47.63)	1.875 (47.63)	2.438 (61.91)	2.438 (61.91)	2.438 (61.91)	2.813 (71.44)	2.813 (71.44)	2.813 (71.44)
	O.S.	2.250 (57.15)	2.250 (57.15)	2.250 (57.15)	2.688 (68.26)	2.688 (68.26)	2.688 (68.26)	3.063 (77.79)	3.063 (77.79)	3.063 (77.79)
ZB	Std.	4.875 (123.83)	4.938 (125.41)	5.063 (128.59)	6.000 (152.40)	6.000 (152.40)	6.313 (160.34)	7.063 (179.39)	7.313 (185.74)	7.313 (185.74)
	O.S.	5.250 (133.35)	5.313 (134.94)	5.438 (138.11)	6.250 (158.75)	6.250 (158.75)	6.563 (166.69)	7.313 (185.74)	7.563 (192.09)	7.563 (192.09)

All dimensions in inches (mm)

Code 17 Head Trunnion Mounts (ANSI MT1)

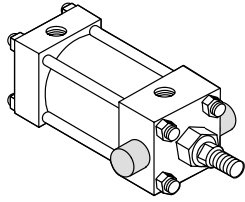

These mounts are for applications in which the machine member travels in a curved path in one plane.

The mount can be used both in compression (push) and tension (pull) applications. When used in compression applications, head trunnion mounts provide a longer maximum stroke than cap trunnion mounts.

NOTE

For strokes in excess of 30 inches, see "Stop Tube Selection" on page 45.

It is recommended that rigidly mounted pillow blocks with bearings at least as long as the trunnion pins be used. The pillow blocks should be installed as close to the shoulder of the trunnion as possible.

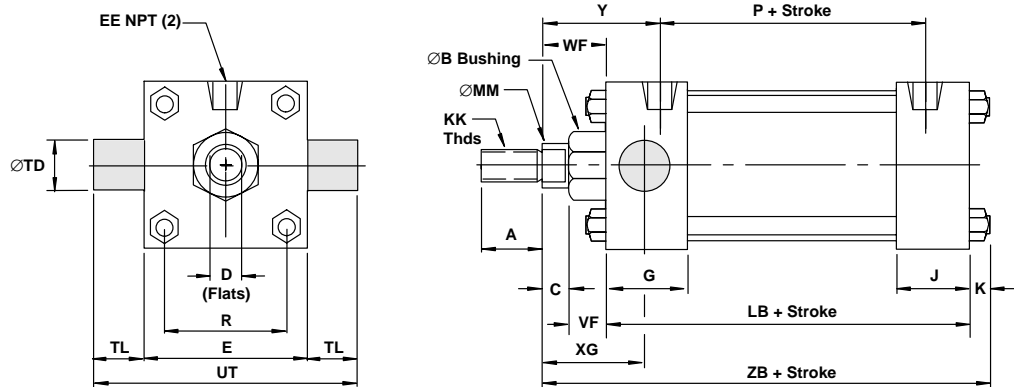

Dimension	1 1/2" Bore (38.10)	2" Bore (50.80)	2 1/2" Bore (63.50)	3 1/2" Bore (82.55)	4" Bore (101.60)	5" Bore (127.00)	6" Bore (152.40)	7" Bore (177.80)	8" Bore (203.20)
ØRod	Std. 5/8" (15.88)	5/8" (15.88)	5/8" (15.88)	1" (25.40)	1" (25.40)	1" (25.40)	1-3/8" (34.93)	1-3/8" (34.93)	1-3/8" (34.93)
	O.S. 1" (25.40)	1" (25.40)	1" (25.40)	1-3/8" (34.93)	1-3/8" (34.93)	1-3/8" (34.93)	1-3/4" (44.45)	1-3/4" (44.45)	1-3/4" (44.45)
A	Std. .750 (19.05)	.750 (19.05)	.750 (19.05)	1.125 (28.58)	1.125 (28.58)	1.125 (28.58)	1.625 (41.28)	1.625 (41.28)	1.625 (41.28)
	O.S. 1.125 (28.58)	1.125 (28.58)	1.125 (28.58)	1.625 (41.28)	1.625 (41.28)	1.625 (41.28)	2.000 (50.80)	2.000 (50.80)	2.000 (50.80)
B+000 -002	Std. 1.124 (28.55)	1.124 (28.55)	1.124 (28.55)	1.499 (38.08)	1.499 (38.08)	1.499 (38.08)	1.999 (50.78)	1.999 (50.78)	1.999 (50.78)
	O.S. 1.499 (38.08)	1.499 (38.08)	1.499 (38.08)	1.999 (50.78)	1.999 (50.78)	1.999 (50.78)	2.374 (60.30)	2.374 (60.30)	2.374 (60.30)
C	Std. .375 (9.53)	.375 (9.53)	.375 (9.53)	.500 (12.70)	.500 (12.70)	.500 (12.70)	.625 (15.88)	.625 (15.88)	.625 (15.88)
	O.S. .500 (12.70)	.500 (12.70)	.500 (12.70)	.625 (15.88)	.625 (15.88)	.625 (15.88)	.750 (19.05)	.750 (19.05)	.750 (19.05)
CC	Std. 1/2 - 20	1/2 - 20	1/2 - 20	7/8 - 14	7/8 - 14	7/8 - 14	1-1/4 - 12	1-1/4 - 12	1-1/4 - 12
	O.S. 7/8 - 14	7/8 - 14	7/8 - 14	1-1/4 - 12	1-1/4 - 12	1-1/4 - 12	1-1/2 - 12	1-1/2 - 12	1-1/2 - 12
D	Std. .500 (12.70)	.500 (12.70)	.500 (12.70)	.875 (22.23)	.875 (22.23)	.875 (22.23)	1.125 (28.58)	1.125 (28.58)	1.125 (28.58)
	O.S. .875 (22.23)	.875 (22.23)	.875 (22.23)	1.125 (28.58)	1.125 (28.58)	1.125 (28.58)	1.500 (38.10)	1.500 (38.10)	1.500 (38.10)
E	2.000 (50.80)	2.500 (63.50)	3.000 (76.20)	3.750 (95.25)	4.500 (114.30)	5.500 (139.70)	6.500 (165.10)	7.500 (190.50)	8.500 (215.90)
EE	.375 (9.53)	.375 (9.53)	.375 (9.53)	.500 (12.70)	.500 (12.70)	.500 (12.70)	.750 (19.05)	.750 (19.05)	.750 (19.05)
FF	Std. 5/8 - 18	5/8 - 18	5/8 - 18	1 - 14	1 - 14	1 - 14	1-3/8 - 12	1-3/8 - 12	1-3/8 - 12
	O.S. 1 - 14	1 - 14	1 - 14	1-3/8 - 12	1-3/8 - 12	1-3/8 - 12	1-3/4 - 12	1-3/4 - 12	1-3/4 - 12
G	1.500 (38.10)	1.500 (38.10)	1.500 (38.10)	1.750 (44.45)	1.750 (44.45)	1.750 (44.45)	2.000 (50.80)	2.000 (50.80)	2.000 (50.80)
J	1.000 (25.40)	1.000 (25.40)	1.000 (25.40)	1.250 (31.75)	1.250 (31.75)	1.250 (31.75)	1.500 (38.10)	1.500 (38.10)	1.500 (38.10)
K	.250 (6.35)	.313 (7.94)	.313 (7.94)	.375 (9.53)	.375 (9.53)	.438 (11.11)	.438 (11.11)	.563 (14.29)	.563 (14.29)
KK	Std. 7/16 - 20	7/16 - 20	7/16 - 20	3/4 - 16	3/4 - 16	3/4 - 16	1 - 14	1 - 14	1 - 14
	O.S. 3/4 - 16	3/4 - 16	3/4 - 16	1 - 14	1 - 14	1 - 14	1-1/4 - 12	1-1/4 - 12	1-1/4 - 12
LB	3.625 (92.08)	3.625 (92.08)	3.750 (95.25)	4.250 (107.95)	4.250 (107.95)	4.500 (114.30)	5.000 (127.00)	5.125 (130.18)	5.125 (130.18)
MM	Std. .625 (15.88)	.625 (15.88)	.625 (15.88)	1.000 (25.40)	1.000 (25.40)	1.000 (25.40)	1.375 (34.93)	1.375 (34.93)	1.375 (34.93)
	O.S. 1.000 (25.40)	1.000 (25.40)	1.000 (25.40)	1.375 (34.93)	1.375 (34.93)	1.375 (34.93)	1.750 (44.45)	1.750 (44.45)	1.750 (44.45)
P	2.313 (58.74)	2.313 (58.74)	2.438 (61.91)	2.625 (66.68)	2.625 (66.68)	2.875 (73.03)	3.125 (79.38)	3.250 (82.55)	3.250 (82.55)
R	1.428 (36.27)	1.838 (46.68)	2.192 (55.67)	2.758 (70.05)	3.323 (84.40)	4.101 (104.16)	4.879 (123.92)	5.730 (145.54)	6.435 (163.44)
TD +000 -001	1.000 (25.40)	1.000 (25.40)	1.000 (25.40)	1.000 (25.40)	1.000 (25.40)	1.000 (25.40)	1.375 (34.93)	1.375 (34.93)	1.375 (34.93)
TL	1.000 (25.40)	1.000 (25.40)	1.000 (25.40)	1.000 (25.40)	1.000 (25.40)	1.000 (25.40)	1.375 (34.93)	1.375 (34.93)	1.375 (34.93)
UT	4.000 (101.60)	4.500 (114.30)	5.000 (127.00)	5.750 (146.05)	6.500 (165.10)	7.500 (190.50)	9.250 (234.95)	10.250 (260.35)	11.250 (285.75)
VF	Std. .625 (15.88)	.625 (15.88)	.625 (15.88)	.875 (22.23)	.875 (22.23)	.875 (22.23)	1.000 (25.40)	1.000 (25.40)	1.000 (25.40)
	O.S. .875 (22.23)	.875 (22.23)	.875 (22.23)	1.000 (25.40)	1.000 (25.40)	1.000 (25.40)	1.125 (28.58)	1.125 (28.58)	1.125 (28.58)
WF	Std. 1.000 (25.40)	1.000 (25.40)	1.000 (25.40)	1.375 (34.93)	1.375 (34.93)	1.375 (34.93)	1.625 (41.28)	1.625 (41.28)	1.625 (41.28)
	O.S. 1.375 (34.93)	1.375 (34.93)	1.375 (34.93)	1.625 (41.28)	1.625 (41.28)	1.625 (41.28)	1.875 (47.63)	1.875 (47.63)	1.875 (47.63)
XJ	Std. 4.125 (104.78)	4.125 (104.78)	4.250 (107.95)	5.000 (127.00)	5.250 (133.35)	5.500 (139.70)	6.125 (155.58)	6.250 (158.75)	6.250 (158.75)
	O.S. 5.750 (146.05)	5.750 (146.05)	5.875 (149.23)	7.125 (180.98)	7.125 (180.98)	7.375 (187.33)	8.375 (212.73)	8.500 (215.90)	8.500 (215.90)
Y	Std. 1.875 (47.63)	1.875 (47.63)	1.875 (47.63)	2.438 (61.91)	2.438 (61.91)	2.438 (61.91)	2.813 (71.44)	2.813 (71.44)	2.813 (71.44)
	O.S. 2.250 (57.15)	2.250 (57.15)	2.250 (57.15)	2.688 (68.26)	2.688 (68.26)	2.688 (68.26)	3.063 (77.79)	3.063 (77.79)	3.063 (77.79)
ZB	Std. 4.875 (123.83)	4.938 (125.41)	5.063 (128.59)	6.000 (152.40)	6.000 (152.40)	6.313 (160.34)	7.063 (179.39)	7.313 (185.74)	7.313 (185.74)
	O.S. 5.250 (133.35)	5.313 (134.94)	5.438 (138.11)	6.250 (158.75)	6.250 (158.75)	6.563 (166.69)	7.313 (185.74)	7.563 (192.09)	7.563 (192.09)

All dimensions in inches (mm)

Code 18 Sleeve Nut, for Tapped Face Mounts

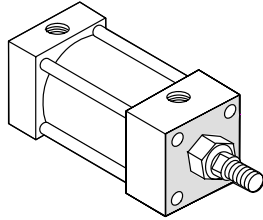

16 Sleeve Nut Construction
Basic Cylinder Side Tapped (Universal)

These mounts are for straight line force transfer applications in which the cylinder is used in tension (pulling).

The mounting surface should be flat and the rod end cartridge should be piloted into it.

The frame on which the cylinder is mounted must be sufficiently rigid to resist bending moments.

NOTE

For strokes in excess of 30 inches, see "Stop Tube Selection" on page 45.

The force of the load should be perpendicular to the mounting surface and parallel to the centerline of the piston rod. For eccentric loads, the larger of the two available rods in each bore size is recommended. Stop tubes should also be considered.

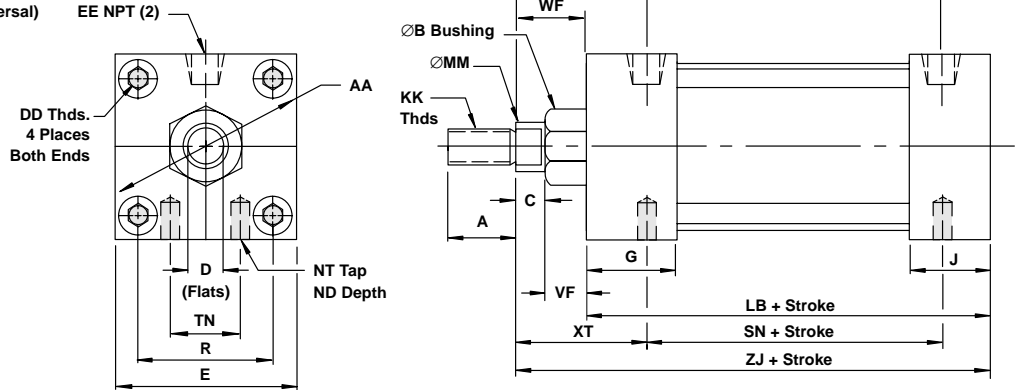

Dimension		1 1/2" Bore (38.10)	2" Bore (50.80)	2 1/2" Bore (63.50)	3 1/4" Bore (82.55)	4" Bore (101.60)	5" Bore (127.00)	6" Bore (152.40)
ø Rod	Std.	5/8" (15.88)	5/8" (15.88)	5/8" (15.88)	1" (25.40)	1" (25.40)	1" (25.40)	1-3/8" (34.93)
	O.S.	1" (25.40)	1" (25.40)	1" (25.40)	1-3/8" (34.93)	1-3/8" (34.93)	1-3/8" (34.93)	1-3/4" (44.45)
A	Std.	.750 (19.05)	.750 (19.05)	.750 (19.05)	1.125 (28.58)	1.125 (28.58)	1.125 (28.58)	1.625 (41.28)
	O.S.	1.125 (28.58)	1.125 (28.58)	1.125 (28.58)	1.625 (41.28)	1.625 (41.28)	1.625 (41.28)	2.000 (50.80)
AA	Std.	2.020 (51.31)	2.600 (66.04)	3.100 (78.74)	3.900 (99.06)	4.700 (119.38)	5.800 (147.32)	6.900 (175.26)
	O.S.	1.124 (28.55)	1.124 (28.55)	1.124 (28.55)	1.499 (38.08)	1.499 (38.08)	1.499 (38.08)	1.999 (50.78)
B + .000 - .002	Std.	1.124 (28.55)	1.124 (28.55)	1.124 (28.55)	1.499 (38.08)	1.499 (38.08)	1.499 (38.08)	2.374 (60.30)
	O.S.	1.499 (38.08)	1.499 (38.08)	1.499 (38.08)	1.999 (50.78)	1.999 (50.78)	1.999 (50.78)	2.374 (60.30)
C	Std.	.375 (9.53)	.375 (9.53)	.375 (9.53)	.500 (12.70)	.500 (12.70)	.500 (12.70)	.625 (15.88)
	O.S.	.500 (12.70)	.500 (12.70)	.500 (12.70)	.625 (15.88)	.625 (15.88)	.625 (15.88)	.750 (19.05)
CC	Std.	1/2 - 20	1/2 - 20	1/2 - 20	7/8 - 14	7/8 - 14	7/8 - 14	1-1/4 - 12
	O.S.	7/8 - 14	7/8 - 14	7/8 - 14	1-1/4 - 12	1-1/4 - 12	1-1/4 - 12	1-1/2 - 12
D	Std.	.500 (12.70)	.500 (12.70)	.500 (12.70)	.813 (20.64)	.813 (20.64)	.813 (20.64)	1.125 (28.58)
	O.S.	.813 (20.64)	.813 (20.64)	.813 (20.64)	1.125 (28.58)	1.125 (28.58)	1.125 (28.58)	1.500 (38.10)
DD		1/4 - 28	5/16 - 24	5/16 - 24	3/8 - 24	3/8 - 24	1/2 - 20	1/2 - 20
E		2.000 (50.80)	2.500 (63.50)	3.000 (76.20)	3.750 (95.25)	4.500 (114.30)	5.500 (139.70)	6.500 (165.10)
EE		.375 (9.53)	.375 (9.53)	.375 (9.53)	.500 (12.70)	.500 (12.70)	.500 (12.70)	.750 (19.05)
FF	Std.	5/8 - 18	5/8 - 18	5/8 - 18	1 - 14	1 - 14	1 - 14	1-3/8 - 12
	O.S.	1 - 14	1 - 14	1 - 14	1-3/8 - 12	1-3/8 - 12	1-3/8 - 12	1-3/4 - 12
G		1.500 (38.10)	1.500 (38.10)	1.500 (38.10)	1.750 (44.45)	1.750 (44.45)	1.750 (44.45)	2.000 (50.80)
J		1.000 (25.40)	1.000 (25.40)	1.000 (25.40)	1.250 (31.75)	1.250 (31.75)	1.250 (31.75)	1.500 (38.10)
KK	Std.	7/16 - 20	7/16 - 20	7/16 - 20	3/4 - 16	3/4 - 16	3/4 - 16	1 - 14
	O.S.	3/4 - 16	3/4 - 16	3/4 - 16	1 - 14	1 - 14	1 - 14	1-1/4 - 12
LB		3.625 (92.08)	3.625 (92.08)	3.750 (95.25)	4.250 (107.95)	4.250 (107.95)	4.500 (114.30)	5.000 (127.00)
MM	Std.	.625 (15.88)	.625 (15.88)	.625 (15.88)	1.000 (25.40)	1.000 (25.40)	1.000 (25.40)	1.375 (34.93)
	O.S.	1.000 (25.40)	1.000 (25.40)	1.000 (25.40)	1.375 (34.93)	1.375 (34.93)	1.375 (34.93)	1.750 (44.45)
NT		1/4 - 20	5/16 - 18	3/8 - 16	1/2 - 13	1/2 - 13	5/8 - 11	3/4 - 10
ND		.375 (9.53)	.375 (9.53)	.500 (12.70)	.750 (19.05)	.750 (19.05)	.938 (23.81)	1.125 (28.58)
P		2.313 (58.74)	2.313 (58.74)	2.438 (61.91)	2.625 (66.68)	2.625 (66.68)	2.875 (73.03)	3.125 (79.38)
R		1.428 (36.27)	1.838 (46.68)	2.192 (55.67)	2.758 (70.05)	3.323 (84.40)	4.101 (104.16)	4.879 (123.92)
SN		2.250 (57.15)	2.250 (57.15)	2.375 (60.33)	2.625 (66.68)	2.625 (66.68)	2.875 (73.03)	3.125 (79.38)
TN		.625 (15.88)	.875 (22.23)	1.250 (31.75)	1.500 (38.10)	2.063 (52.39)	2.688 (68.26)	3.250 (82.55)
VF	Std.	.625 (15.88)	.625 (15.88)	.625 (15.88)	.875 (22.23)	.875 (22.23)	.875 (22.23)	1.000 (25.40)
	O.S.	.875 (22.23)	.875 (22.23)	.875 (22.23)	1.000 (25.40)	1.000 (25.40)	1.000 (25.40)	1.125 (28.58)
WF	Std.	1.000 (25.40)	1.000 (25.40)	1.000 (25.40)	1.375 (34.93)	1.375 (34.93)	1.375 (34.93)	1.625 (41.28)
	O.S.	1.375 (34.93)	1.375 (34.93)	1.375 (34.93)	1.625 (41.28)	1.625 (41.28)	1.625 (41.28)	1.875 (47.63)
XT	Std.	1.938 (49.21)	1.938 (49.21)	1.938 (49.21)	2.438 (61.91)	2.438 (61.91)	2.438 (61.91)	2.813 (71.44)
	O.S.	2.313 (58.74)	2.313 (58.74)	2.313 (58.74)	2.688 (68.26)	2.688 (68.26)	2.688 (68.26)	3.063 (77.79)
Y	Std.	1.875 (47.63)	1.875 (47.63)	1.875 (47.63)	2.438 (61.91)	2.438 (61.91)	2.438 (61.91)	2.813 (71.44)
	O.S.	2.250 (57.15)	2.250 (57.15)	2.250 (57.15)	2.688 (68.26)	2.688 (68.26)	2.688 (68.26)	3.063 (77.79)
ZJ	Std.	4.625 (117.48)	4.625 (117.48)	4.750 (120.65)	5.625 (142.88)	5.625 (142.88)	5.625 (142.88)	6.625 (168.28)
	O.S.	5.000 (127.00)	5.000 (127.00)	5.125 (130.18)	5.875 (149.23)	5.875 (149.23)	5.875 (149.23)	6.875 (174.63)

All dimensions in inches (mm)

Codes 21 Cap (MX2), 22 Head (MX3), & 23 Both Ends (MX1) Extended Tie Rod Mounts

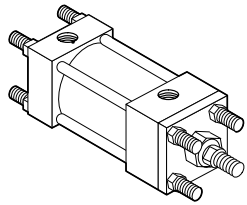

These mounts are for straight line force transfer applications. Both ends extended tie rod mounts are suited for tension and compression applications or applications where additional hardware is to be attached to cylinders.

The mounting surface should be flat and the frame on which the cylinder is mounted must be sufficiently rigid to resist bending moments.

Once fitted into the application framework, the nuts which are provided should be torqued to the values listed in the right column table.

NOTE

For strokes in excess of 30 inches, see "Stop Tube Selection" on page 45.

The force on the rod should be perpendicular to the mounting surface and coincide with the centerline of the piston rod. For eccentric loads, the larger of the two available rods in each bore size is recommended. Stop tubes should also be considered.

Recommended Torques for Tightening Tie Rods

Cylinder Bore	Series VP Steel Tie Rod	Series VN Stainless Tie Rod
1-1/2"	6.6 ft. lbs.	3.75 ft. lbs.
2"	11 ft. lbs.	7.5 ft. lbs.
2-1/2"	13 ft. lbs.	7.5 ft. lbs.
3-3/4"	20 ft. lbs.	14 ft. lbs.
4"	24 ft. lbs.	14 ft. lbs.
5"	40 ft. lbs.	33 ft. lbs.
6"	48 ft. lbs.	33 ft. lbs.
7" & 8"	100 ft. lbs.	65 ft. lbs.

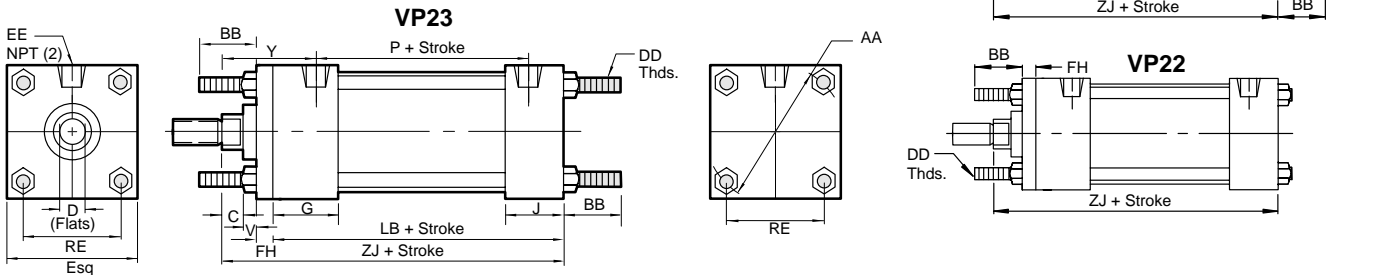

Dimension	1 1/2" Bore (38.10)	2" Bore (50.80)	2 1/2" Bore (63.50)	3 1/4" Bore (82.55)	4" Bore (101.60)	5" Bore (127.00)	6" Bore (152.40)	7" Bore (177.80)	8" Bore (203.20)
øRod	Std. 5/8" (15.88)	5/8" (15.88)	5/8" (15.88)	1" (25.40)	1" (25.40)	1" (25.40)	1-3/8" (34.93)	1-3/8" (34.93)	1-3/8" (34.93)
	O.S. 1" (25.40)	1" (25.40)	1" (25.40)	1-3/8" (34.93)	1-3/8" (34.93)	1-3/8" (34.93)	1-3/4" (44.45)	1-3/4" (44.45)	1-3/4" (44.45)
A	Std. .750 (19.05)	.750 (19.05)	.750 (19.05)	1.125 (28.58)	1.125 (28.58)	1.125 (28.58)	1.625 (41.28)	1.625 (41.28)	1.625 (41.28)
	O.S. 1.125 (28.58)	1.125 (28.58)	1.125 (28.58)	1.625 (41.28)	1.625 (41.28)	1.625 (41.28)	2.000 (50.80)	2.000 (50.80)	2.000 (50.80)
B+.000 -.002	Std. 1.124 (28.55)	1.124 (28.55)	1.124 (28.55)	1.499 (38.08)	1.499 (38.08)	1.499 (38.08)	1.999 (50.78)	1.999 (50.78)	1.999 (50.78)
	O.S. 1.499 (38.08)	1.499 (38.08)	1.499 (38.08)	1.999 (50.78)	1.999 (50.78)	1.999 (50.78)	2.374 (60.30)	2.374 (60.30)	2.374 (60.30)
BB	1.000 (25.40)	1.125 (28.58)	1.125 (28.58)	1.375 (34.93)	1.375 (34.93)	1.813 (46.04)	1.813 (46.04)	2.313 (58.74)	2.313 (58.74)
C	Std. .375 (9.53)	.375 (9.53)	.375 (9.53)	.500 (12.70)	.500 (12.70)	.500 (12.70)	.625 (15.88)	.625 (15.88)	.625 (15.88)
	O.S. .500 (12.70)	.500 (12.70)	.500 (12.70)	.625 (15.88)	.625 (15.88)	.625 (15.88)	.750 (19.05)	.750 (19.05)	.750 (19.05)**
CC	Std. 1/2 - 20	1/2 - 20	1/2 - 20	7/8 - 14	7/8 - 14	7/8 - 14	1-1/4 - 12	1-1/4 - 12	1-1/4 - 12
	O.S. 7/8 - 14	7/8 - 14	7/8 - 14	1-1/4 - 12	1-1/4 - 12	1-1/4 - 12	1-1/2 - 12	1-1/2 - 12	1-1/2 - 12
D	Std. .500 (12.70)	.500 (12.70)	.500 (12.70)	.875 (22.23)	.875 (22.23)	.875 (22.23)	1.125 (28.58)	1.125 (28.58)	1.125 (28.58)
	O.S. .813 (20.64)	.813 (20.64)	.813 (20.64)	1.125 (28.58)	1.125 (28.58)	1.125 (28.58)	1.500 (38.10)	1.500 (38.10)	1.500 (38.10)
DD	1/4 - 28	5/16 - 24	5/16 - 24	3/8 - 24	3/8 - 24	1/2 - 20	1/2 - 20	5/8 - 18	5/8 - 18
E	2.000 (50.80)	2.500 (63.50)	3.000 (76.20)	3.750 (95.25)	4.500 (114.30)	5.500 (139.70)	6.500 (165.10)	7.500 (190.50)	8.500 (215.90)
EE	.375 (9.53)	.375 (9.53)	.375 (9.53)	.500 (12.70)	.500 (12.70)	.500 (12.70)	.750 (19.05)	.750 (19.05)	.750 (19.05)
F	.375 (9.53)	.375 (9.53)	.375 (9.53)	.625 (15.88)	.625 (15.88)	.625 (15.88)	.750 (19.05)	.750 (19.05)	.750 (19.05)
FF	Std. 5/8 - 18	5/8 - 18	5/8 - 18	1 - 14	1 - 14	1 - 14	1-3/8 - 12	1-3/8 - 12	1-3/8 - 12
	O.S. 1 - 14	1 - 14	1 - 14	1-3/8 - 12	1-3/8 - 12	1-3/8 - 12	1-3/4 - 12	1-3/4 - 12	1-3/4 - 12
G	1.500 (38.10)	1.500 (38.10)	1.500 (38.10)	1.750 (44.45)	1.750 (44.45)	1.750 (44.45)	2.000 (50.80)	2.000 (50.80)	2.000 (50.80)
J	1.000 (25.40)	1.000 (25.40)	1.000 (25.40)	1.250 (31.75)	1.250 (31.75)	1.250 (31.75)	1.500 (38.10)	1.500 (38.10)	1.500 (38.10)
K	.250 (6.35)	.313 (7.94)	.313 (7.94)	.375 (9.53)	.375 (9.53)	.438 (11.11)	.438 (11.11)	.563 (14.29)	.563 (14.29)
KK	Std. 7/16 - 20	7/16 - 20	7/16 - 20	3/4 - 16	3/4 - 16	3/4 - 16	1 - 14	1 - 14	1 - 14
	O.S. 3/4 - 16	3/4 - 16	3/4 - 16	1 - 14	1 - 14	1 - 14	1-1/4 - 12	1-1/4 - 12	1-1/4 - 12
LB	3.625 (92.08)	3.625 (92.08)	3.750 (95.25)	4.250 (107.95)	4.250 (107.95)	4.500 (114.30)	5.000 (127.00)	5.125 (130.18)	5.125 (130.18)
MM	Std. .625 (15.88)	.625 (15.88)	.625 (15.88)	1.000 (25.40)	1.000 (25.40)	1.000 (25.40)	1.375 (34.93)	1.375 (34.93)	1.375 (34.93)
	O.S. 1.000 (25.40)	1.000 (25.40)	1.000 (25.40)	1.375 (34.93)	1.375 (34.93)	1.375 (34.93)	1.750 (44.45)	1.750 (44.45)	1.750 (44.45)
P	2.313 (58.74)	2.313 (58.74)	2.438 (61.91)	2.625 (66.68)	2.625 (66.68)	2.875 (73.03)	3.125 (79.38)	3.250 (82.55)	3.250 (82.55)
R	1.428 (36.27)	1.838 (46.68)	2.192 (55.67)	2.758 (70.05)	3.323 (84.40)	4.101 (104.16)	4.879 (123.92)	5.730 (145.54)	6.442 (163.63)
VF	Std. .625 (15.88)	.625 (15.88)	.625 (15.88)	.875 (22.23)	.875 (22.23)	.875 (22.23)	1.000 (25.40)	1.000 (25.40)	1.000 (25.40)
	O.S. .875 (22.23)	.875 (22.23)	.875 (22.23)	1.000 (25.40)	1.000 (25.40)	1.000 (25.40)	1.125 (28.58)	1.125 (28.58)	1.125 (28.58)
WF	Std. 1.000 (25.40)	1.000 (25.40)	1.000 (25.40)	1.375 (34.93)	1.375 (34.93)	1.375 (34.93)	1.625 (41.28)	1.625 (41.28)	1.625 (41.28)
	O.S. 1.375 (34.93)	1.375 (34.93)	1.375 (34.93)	1.625 (41.28)	1.625 (41.28)	1.625 (41.28)	1.875 (47.63)	1.875 (47.63)	1.875 (47.63)
Y	Std. 1.875 (47.63)	1.875 (47.63)	1.875 (47.63)	2.438 (61.91)	2.438 (61.91)	2.438 (61.91)	2.813 (71.44)	2.813 (71.44)	2.813 (71.44)
	O.S. 2.250 (57.15)	2.250 (57.15)	2.250 (57.15)	2.688 (68.26)	2.688 (68.26)	2.688 (68.26)	3.063 (77.79)	3.063 (77.79)	3.063 (77.79)
ZB	Std. 4.875 (123.83)	4.938 (125.41)	5.063 (128.59)	6.000 (152.40)	6.000 (152.40)	6.313 (160.34)	7.063 (179.39)	7.313 (185.74)	7.313 (185.74)
	O.S. 5.250 (133.35)	5.313 (134.94)	5.438 (138.11)	6.250 (158.75)	6.250 (158.75)	6.563 (166.69)	7.313 (185.74)	7.563 (192.09)	7.563 (192.09)

**BB dimension on 8 bore is from the head.
All dimensions in inches (mm)

Code 24 No Mount Cylinder (ANSI MX0)

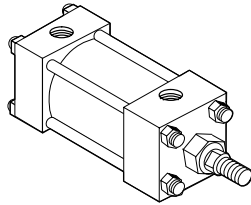

The basic cylinder is often used by customers who have designed their own method of mounting. These mounting methods may include custom made mounting flanges, machining into the end caps, and clamping mechanisms to secure the cylinder. Consult Vickers engineering when using the cylinder in this fashion.

NOTE

For strokes in excess of 30 inches, see "Stop Tube Selection" on page 45.

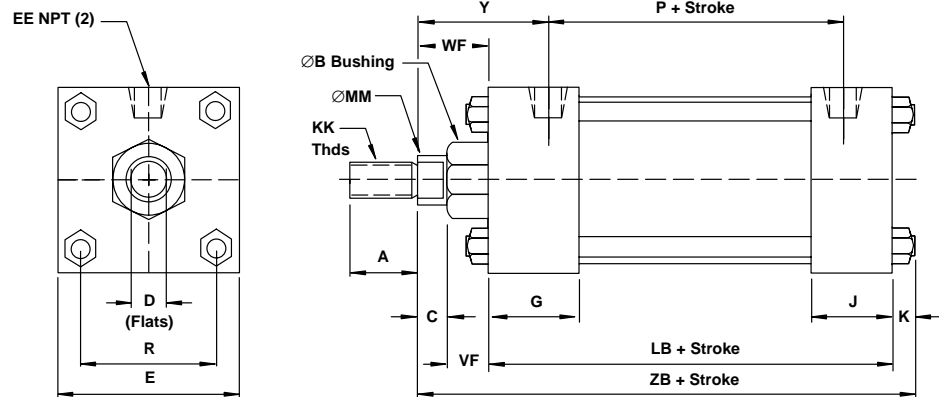

Dimension	1½" Bore (38.10)	2" Bore (50.80)	2½" Bore (63.50)	3¼" Bore (82.55)	4" Bore (101.60)	5" Bore (127.00)	6" Bore (152.40)	7" Bore (177.80)	8" Bore (203.20)
ØRod	Std. 5/8" (15.88)	5/8" (15.88)	5/8" (15.88)	1" (25.40)	1" (25.40)	1" (25.40)	1-3/8" (34.93)	1-3/8" (34.93)	1-3/8" (34.93)
	O.S. 1" (25.40)	1" (25.40)	1" (25.40)	1-3/8" (34.93)	1-3/8" (34.93)	1-3/8" (34.93)	1-3/4" (44.45)	1-3/4" (44.45)	1-3/4" (44.45)
A	Std. .750 (19.05)	.750 (19.05)	.750 (19.05)	1.125 (28.58)	1.125 (28.58)	1.125 (28.58)	1.625 (41.28)	1.625 (41.28)	1.625 (41.28)
	O.S. 1.125 (28.58)	1.125 (28.58)	1.125 (28.58)	1.625 (41.28)	1.625 (41.28)	1.625 (41.28)	2.000 (50.80)	2.000 (50.80)	2.000 (50.80)
B+000-002	Std. 1.124 (28.55)	1.124 (28.55)	1.124 (28.55)	1.499 (38.08)	1.499 (38.08)	1.499 (38.08)	1.999 (50.78)	1.999 (50.78)	1.999 (50.78)
	O.S. 1.499 (38.08)	1.499 (38.08)	1.499 (38.08)	1.999 (50.78)	1.999 (50.78)	1.999 (50.78)	2.374 (60.30)	2.374 (60.30)	2.374 (60.30)
C	Std. .375 (9.53)	.375 (9.53)	.375 (9.53)	.500 (12.70)	.500 (12.70)	.500 (12.70)	.625 (15.88)	.625 (15.88)	.625 (15.88)
	O.S. .500 (12.70)	.500 (12.70)	.500 (12.70)	.625 (15.88)	.625 (15.88)	.625 (15.88)	.750 (19.05)	.750 (19.05)	.750 (19.05)
CC	Std. 1/2 - 20	1/2 - 20	1/2 - 20	7/8 - 14	7/8 - 14	7/8 - 14	1-1/4 - 12	1-1/4 - 12	1-1/4 - 12
	O.S. 7/8 - 14	7/8 - 14	7/8 - 14	1-1/4 - 12	1-1/4 - 12	1-1/4 - 12	1-1/2 - 12	1-1/2 - 12	1-1/2 - 12
D	Std. .500 (12.70)	.500 (12.70)	.500 (12.70)	.875 (22.23)	.875 (22.23)	.875 (22.23)	1.125 (15.88)	1.125 (15.88)	1.125 (15.88)
	O.S. .813 (20.64)	.813 (20.64)	.813 (20.64)	1.125 (28.58)	1.125 (28.58)	1.125 (28.58)	1.500 (38.10)	1.500 (38.10)	1.500 (38.10)
E	2.000 (50.80)	2.500 (63.50)	3.000 (76.20)	3.750 (95.25)	4.500 (114.30)	5.500 (139.70)	6.500 (165.10)	7.500 (190.50)	8.500 (215.90)
EE	.375 (9.53)	.375 (9.53)	.375 (9.53)	.500 (12.70)	.500 (12.70)	.500 (12.70)	.750 (19.05)	.750 (19.05)	.750 (19.05)
FF	Std. 5/8 - 18	5/8 - 18	5/8 - 18	1 - 14	1 - 14	1 - 14	1-3/8 - 12	1-3/8 - 12	1-3/8 - 12
	O.S. 1 - 14	1 - 14	1 - 14	1-3/8 - 12	1-3/8 - 12	1-3/8 - 12	1-3/4 - 12	1-3/4 - 12	1-3/4 - 12
G	1.500 (38.10)	1.500 (38.10)	1.500 (38.10)	1.750 (44.45)	1.750 (44.45)	1.750 (44.45)	2.000 (50.80)	2.000 (50.80)	2.000 (50.80)
J	1.000 (25.40)	1.000 (25.40)	1.000 (25.40)	1.250 (31.75)	1.250 (31.75)	1.250 (31.75)	1.500 (38.10)	1.500 (38.10)	1.500 (38.10)
K	.250 (6.35)	.313 (7.94)	.313 (7.94)	.375 (9.53)	.375 (9.53)	.438 (11.11)	.438 (11.11)	.563 (14.29)	.563 (14.29)
KK	Std. 7/16 - 20	7/16 - 20	7/16 - 20	3/4 - 16	3/4 - 16	3/4 - 16	1 - 14	1 - 14	1 - 14
	O.S. 3/4 - 16	3/4 - 16	3/4 - 16	1 - 14	1 - 14	1 - 14	1-1/4 - 12	1-1/4 - 12	1-1/4 - 12
LB	3.625 (92.08)	3.625 (92.08)	3.750 (95.25)	4.250 (107.95)	4.250 (107.95)	4.500 (114.30)	5.000 (127.00)	5.125 (130.18)	5.125 (130.18)
MM	Std. .625 (15.88)	.625 (15.88)	.625 (15.88)	1.000 (25.40)	1.000 (25.40)	1.000 (25.40)	1.375 (34.93)	1.375 (34.93)	1.375 (34.93)
	O.S. 1.000 (25.40)	1.000 (25.40)	1.000 (25.40)	1.375 (34.93)	1.375 (34.93)	1.375 (34.93)	1.750 (44.45)	1.750 (44.45)	1.750 (44.45)
P	2.313 (58.74)	2.313 (58.74)	2.438 (61.91)	2.625 (66.68)	2.625 (66.68)	2.875 (73.03)	3.125 (79.38)	3.250 (82.55)	3.250 (82.55)
R	1.428 (36.27)	1.838 (46.68)	2.192 (55.67)	2.758 (70.05)	3.323 (84.40)	4.101 (104.16)	4.879 (123.92)	5.730 (145.54)	6.442 (163.63)
VF	Std. .625 (15.88)	.625 (15.88)	.625 (15.88)	.875 (22.23)	.875 (22.23)	.875 (22.23)	1.000 (25.40)	1.000 (25.40)	1.000 (25.40)
	O.S. .875 (22.23)	.875 (22.23)	.875 (22.23)	1.000 (25.40)	1.000 (25.40)	1.000 (25.40)	1.125 (28.58)	1.125 (28.58)	1.125 (28.58)
WF	Std. 1.000 (25.40)	1.000 (25.40)	1.000 (25.40)	1.375 (34.93)	1.375 (34.93)	1.375 (34.93)	1.625 (41.28)	1.625 (41.28)	1.625 (41.28)
	O.S. 1.375 (34.93)	1.375 (34.93)	1.375 (34.93)	1.625 (41.28)	1.625 (41.28)	1.625 (41.28)	1.875 (47.63)	1.875 (47.63)	1.875 (47.63)
Y	Std. 1.875 (47.63)	1.875 (47.63)	1.875 (47.63)	2.438 (61.91)	2.438 (61.91)	2.438 (61.91)	2.813 (71.44)	2.813 (71.44)	2.813 (71.44)
	O.S. 2.250 (57.15)	2.250 (57.15)	2.250 (57.15)	2.688 (68.26)	2.688 (68.26)	2.688 (68.26)	3.063 (77.79)	3.063 (77.79)	3.063 (77.79)
ZB	Std. 4.875 (123.83)	4.938 (125.41)	5.063 (128.59)	6.000 (152.40)	6.000 (152.40)	6.313 (160.34)	7.063 (179.39)	7.313 (185.74)	7.313 (185.74)
	O.S. 5.250 (133.35)	5.313 (134.94)	5.438 (138.11)	6.250 (158.75)	6.250 (158.75)	6.563 (166.69)	7.313 (185.74)	7.563 (192.09)	7.563 (192.09)

All dimensions in inches (mm)

Code 41 Double Rod, No Mount

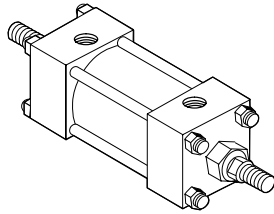

Double rod cylinders are specified when equal displacement is desired on both sides of the piston, or when the application is such that another function can be performed simultaneously with a second rod. The single rod mount application data is also applicable to double rod cylinders.

Rod and pilot related dimensions are typical for both ends.

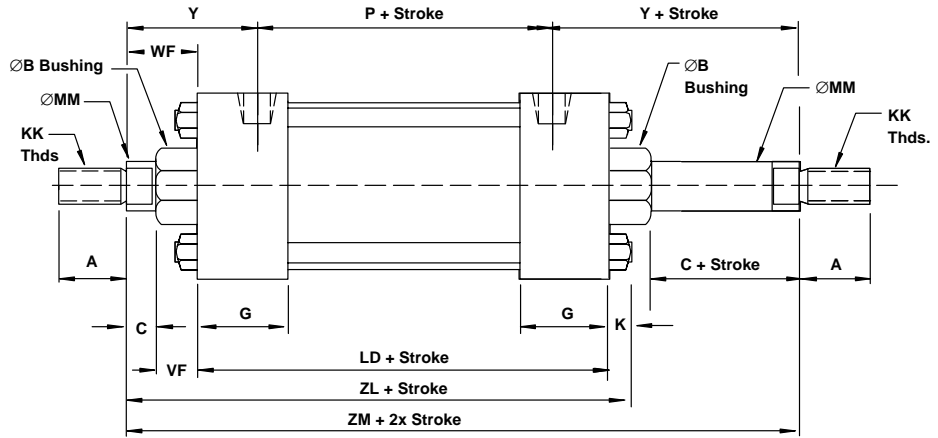
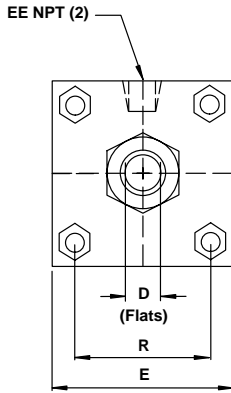

Dimension		1 1/2" Bore (38.10)	2" Bore (50.80)	2 1/2" Bore (63.50)	3 1/4" Bore (82.55)	4" Bore (101.60)	5" Bore (127.00)	6" Bore (152.40)	7" Bore (177.80)	8" Bore (203.20)
ø Rod	Std.	5/8" (15.88)	5/8" (15.88)	5/8" (15.88)	1" (25.40)	1" (25.40)	1" (25.40)	1-3/8" (34.93)	1-3/8" (34.93)	1-3/8" (34.93)
	O.S.	1" (25.40)	1" (25.40)	1" (25.40)	1-3/8" (34.93)	1-3/8" (34.93)	1-3/8" (34.93)	1-3/4" (44.45)	1-3/4" (44.45)	1-3/4" (44.45)
A	Std.	.750 (19.05)	.750 (19.05)	.750 (19.05)	1.125 (28.58)	1.125 (28.58)	1.125 (28.58)	1.625 (41.28)	1.625 (41.28)	1.625 (41.28)
	O.S.	1.125 (28.58)	1.125 (28.58)	1.125 (28.58)	1.625 (41.28)	1.625 (41.28)	1.625 (41.28)	2.000 (50.80)	2.000 (50.80)	2.000 (50.80)
B+000 -002	Std.	1.124 (28.55)	1.124 (28.55)	1.124 (28.55)	1.499 (38.08)	1.499 (38.08)	1.499 (38.08)	1.999 (50.78)	1.999 (50.78)	1.999 (50.78)
	O.S.	1.499 (38.08)	1.499 (38.08)	1.499 (38.08)	1.999 (50.78)	1.999 (50.78)	1.999 (50.78)	2.374 (60.30)	2.374 (60.30)	2.374 (60.30)
C	Std.	.375 (9.53)	.375 (9.53)	.375 (9.53)	.500 (12.70)	.500 (12.70)	.500 (12.70)	.625 (15.88)	.625 (15.88)	.625 (15.88)
	O.S.	.500 (12.70)	.500 (12.70)	.500 (12.70)	.625 (15.88)	.625 (15.88)	.625 (15.88)	.750 (19.05)	.750 (19.05)	.750 (19.05)
CC	Std.	1/2 - 20	1/2 - 20	1/2 - 20	7/8 - 14	7/8 - 14	7/8 - 14	1-1/4 - 12	1-1/4 - 12	1-1/4 - 12
	O.S.	7/8 - 14	7/8 - 14	7/8 - 14	1-1/4 - 12	1-1/4 - 12	1-1/4 - 12	1-1/2 - 12	1-1/2 - 12	1-1/2 - 12
D	Std.	.500 (12.70)	.500 (12.70)	.500 (12.70)	.875 (22.23)	.875 (22.23)	.875 (22.23)	1.125 (28.58)	1.125 (28.58)	1.125 (28.58)
	O.S.	.875 (22.23)	.813 (20.64)	.813 (20.64)	1.125 (28.58)	1.125 (28.58)	1.125 (28.58)	1.500 (38.10)	1.500 (38.10)	1.500 (38.10)
E		2.000 (50.80)	2.500 (63.50)	3.000 (76.20)	3.750 (95.25)	4.500 (114.30)	5.500 (139.70)	6.500 (165.10)	7.500 (190.50)	8.500 (215.90)
EE		.375 (9.53)	.375 (9.53)	.375 (9.53)	.500 (12.70)	.500 (12.70)	.500 (12.70)	.750 (19.05)	.750 (19.05)	.750 (19.05)
FF	Std.	5/8 - 18	5/8 - 18	5/8 - 18	1 - 14	1 - 14	1 - 14	1-3/8 - 12	1-3/8 - 12	1-3/8 - 12
	O.S.	1 - 14	1 - 14	1 - 14	1-3/8 - 12	1-3/8 - 12	1-3/8 - 12	1-3/4 - 12	1-3/4 - 12	1-3/4 - 12
G		1.500 (38.10)	1.500 (38.10)	1.500 (38.10)	1.750 (44.45)	1.750 (44.45)	1.750 (44.45)	2.000 (50.80)	2.000 (50.80)	2.000 (50.80)
J		1.000 (25.40)	1.000 (25.40)	1.000 (25.40)	1.250 (31.75)	1.250 (31.75)	1.250 (31.75)	1.500 (38.10)	1.500 (38.10)	1.500 (38.10)
K		.250 (6.35)	.313 (7.94)	.313 (7.94)	.375 (9.53)	.375 (9.53)	.438 (11.11)	.438 (11.11)	.563 (14.29)	.563 (14.29)
KK	Std.	7/16 - 20	7/16 - 20	7/16 - 20	3/4 - 16	3/4 - 16	3/4 - 16	1 - 14	1 - 14	1 - 14
	O.S.	3/4 - 16	3/4 - 16	3/4 - 16	1 - 14	1 - 14	1 - 14	1-1/4 - 12	1-1/4 - 12	1-1/4 - 12
LB		3.625 (92.08)	3.625 (92.08)	3.750 (95.25)	4.250 (107.95)	4.250 (107.95)	4.500 (114.30)	5.000 (127.00)	5.125 (130.18)	5.125 (130.18)
MM	Std.	.625 (15.88)	.625 (15.88)	.625 (15.88)	1.000 (25.40)	1.000 (25.40)	1.000 (25.40)	1.375 (34.93)	1.375 (34.93)	1.375 (34.93)
	O.S.	1.000 (25.40)	1.000 (25.40)	1.000 (25.40)	1.375 (34.93)	1.375 (34.93)	1.375 (34.93)	1.750 (44.45)	1.750 (44.45)	1.750 (44.45)
P		2.313 (58.74)	2.313 (58.74)	2.438 (61.91)	2.625 (66.68)	2.625 (66.68)	2.875 (73.03)	3.125 (79.38)	3.250 (82.55)	3.250 (82.55)
R		1.428 (36.27)	1.838 (46.68)	2.192 (55.67)	2.758 (70.05)	3.323 (84.40)	4.101 (104.16)	4.879 (123.92)	5.730 (145.54)	6.442 (163.63)
VF	Std.	.625 (15.88)	.625 (15.88)	.625 (15.88)	.875 (22.23)	.875 (22.23)	.875 (22.23)	1.000 (25.40)	1.000 (25.40)	1.000 (25.40)
	O.S.	.875 (22.23)	.875 (22.23)	.875 (22.23)	1.000 (25.40)	1.000 (25.40)	1.000 (25.40)	1.125 (28.58)	1.125 (28.58)	1.125 (28.58)
WF	Std.	1.000 (25.40)	1.000 (25.40)	1.000 (25.40)	1.375 (34.93)	1.375 (34.93)	1.375 (34.93)	1.625 (41.28)	1.625 (41.28)	1.625 (41.28)
	O.S.	1.375 (34.93)	1.375 (34.93)	1.375 (34.93)	1.625 (41.28)	1.625 (41.28)	1.625 (41.28)	1.875 (47.63)	1.875 (47.63)	1.875 (47.63)
Y	Std.	1.875 (47.63)	1.875 (47.63)	1.875 (47.63)	2.438 (61.91)	2.438 (61.91)	2.438 (61.91)	2.813 (71.44)	2.813 (71.44)	2.813 (71.44)
	O.S.	2.250 (57.15)	2.250 (57.15)	2.250 (57.15)	2.688 (68.26)	2.688 (68.26)	2.688 (68.26)	3.063 (77.79)	3.063 (77.79)	3.063 (77.79)
ZL	Std.	5.375 (136.53)	5.438 (138.11)	5.563 (141.29)	6.500 (165.10)	6.500 (165.10)	6.813 (174.04)	7.563 (192.09)	7.813 (198.44)	7.813 (198.44)
	O.S.	6.125 (155.58)	6.125 (155.58)	6.250 (158.75)	7.500 (190.50)	7.500 (190.50)	7.500 (190.50)	8.750 (222.25)	8.875 (225.43)	8.875 (225.43)
ZM	O.S.	6.875 (174.63)	6.875 (174.63)	7.000 (177.80)	8.000 (203.20)	8.000 (203.20)	8.000 (203.20)	9.250 (234.95)	9.375 (238.13)	9.375 (238.13)

All dimensions in inches (mm)

Code 45 Angle Mounts (ANSI MS1)

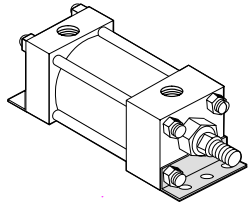

Angle mounts are for moving loads along a flat guided surface as in a carriage along rails. The mounting surface should be flat and parallel to the centerline of the piston rod.

The load should be guided to traverse along the centerline of the piston rod. The frame on which the cylinder is mounted must be sufficiently rigid to resist bending moments.

NOTE

Limit operating pressure to 400 psi (27 bar) non-shock hydraulic for minimum deflection.

For strokes in excess of 30 inches, see "Stop Tube Selection" on page 45.

For applications with unsupported loads, the bearing must absorb more force.

The larger available rod is recommended, and stop tubes should be considered.

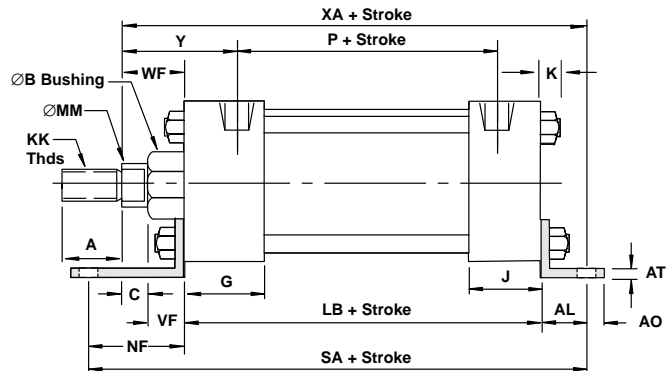
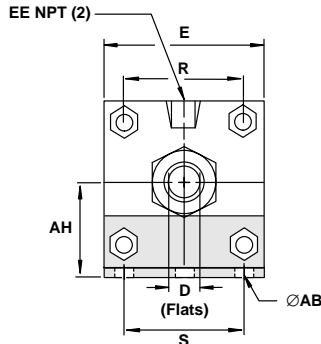

Dimension		1 1/2" Bore (38.10)	2" Bore (50.80)	2 1/2" Bore (63.50)	3 1/4" Bore (82.55)	4" Bore (101.60)	5" Bore (127.00)	6" Bore (152.40)	7" Bore (177.80)	8" Bore (203.20)
∅ Rod	Std.	5/8" (15.88)	5/8" (15.88)	5/8" (15.88)	1" (25.40)	1" (25.40)	1" (25.40)	1-3/8" (34.93)	1-3/8" (34.93)	1-3/8" (34.93)
	O.S.	1" (25.40)	1" (25.40)	1" (25.40)	1-3/8" (34.93)	1-3/8" (34.93)	1-3/8" (34.93)	1-3/4" (44.45)	1-3/4" (44.45)	1-3/4" (44.45)
A	Std.	.750 (19.05)	.750 (19.05)	.750 (19.05)	1.125 (28.58)	1.125 (28.58)	1.125 (28.58)	1.625 (41.28)	1.625 (41.28)	1.625 (41.28)
	O.S.	1.125 (28.58)	1.125 (28.58)	1.125 (28.58)	1.625 (41.28)	1.625 (41.28)	1.625 (41.28)	2.000 (50.80)	2.000 (50.80)	2.000 (50.80)
AB		.438 (11.11)	.438 (11.11)	.438 (11.11)	.563 (14.29)	.563 (14.29)	.688 (17.46)	.813 (20.64)	.813 (20.64)	.813 (20.64)
AH		1.188 (30.16)	1.438 (36.51)	1.625 (41.28)	1.938 (49.21)	2.250 (57.15)	2.750 (69.85)	3.250 (82.55)	3.750 (95.25)	4.250 (107.95)
AL		1.000 (25.40)	1.000 (25.40)	1.000 (25.40)	1.250 (31.75)	1.250 (31.75)	1.375 (34.93)	1.375 (34.93)	1.813 (46.04)	1.813 (46.04)
AO		.375 (9.53)	.375 (9.53)	.375 (9.53)	.500 (12.70)	.500 (12.70)	.625 (15.88)	.625 (15.88)	.688 (17.46)	.688 (17.46)
AT		.125 (3.18)	.125 (3.18)	.125 (3.18)	.125 (3.18)	.125 (3.18)	.187 (4.75)	.187 (4.75)	.250 (6.35)	.250 (6.35)
B ^{+0.000} -0.002	Std.	1.124 (28.55)	1.124 (28.55)	1.124 (28.55)	1.499 (38.08)	1.499 (38.08)	1.499 (38.08)	1.999 (50.78)	1.999 (50.78)	1.999 (50.78)
	O.S.	1.499 (38.08)	1.499 (38.08)	1.499 (38.08)	1.999 (50.78)	1.999 (50.78)	1.999 (50.78)	2.374 (60.30)	2.374 (60.30)	2.374 (60.30)
C	Std.	.375 (9.53)	.375 (9.53)	.375 (9.53)	.500 (12.70)	.500 (12.70)	.500 (12.70)	.625 (15.88)	.625 (15.88)	.625 (15.88)
	O.S.	.500 (12.70)	.500 (12.70)	.500 (12.70)	.625 (15.88)	.625 (15.88)	.625 (15.88)	.750 (19.05)	.750 (19.05)	.750 (19.05)
CC	Std.	1/2 - 20	1/2 - 20	1/2 - 20	7/8 - 14	7/8 - 14	7/8 - 14	1-1/4 - 12	1-1/4 - 12	1-1/4 - 12
	O.S.	7/8 - 14	7/8 - 14	7/8 - 14	1-1/4 - 12	1-1/4 - 12	1-1/4 - 12	1-1/2 - 12	1-1/2 - 12	1-1/2 - 12
D	Std.	.500 (12.70)	.500 (12.70)	.500 (12.70)	.813 (20.64)	.813 (20.64)	.813 (20.64)	1.125 (28.58)	1.125 (28.58)	1.125 (28.58)
	O.S.	.813 (20.64)	.813 (20.64)	.813 (20.64)	1.125 (28.58)	1.125 (28.58)	1.125 (28.58)	1.500 (38.10)	1.500 (38.10)	1.500 (38.10)
E		2.000 (50.80)	2.500 (63.50)	3.000 (76.20)	3.750 (95.25)	4.500 (114.30)	5.500 (139.70)	6.500 (165.10)	7.500 (190.50)	8.500 (215.90)
EE		.375 (9.53)	.375 (9.53)	.375 (9.53)	.500 (12.70)	.500 (12.70)	.500 (12.70)	.750 (19.05)	.750 (19.05)	.750 (19.05)
FF	Std.	5/8 - 18	5/8 - 18	5/8 - 18	1 - 14	1 - 14	1 - 14	1-3/8 - 12	1-3/8 - 12	1-3/8 - 12
	O.S.	1 - 14	1 - 14	1 - 14	1-3/8 - 12	1-3/8 - 12	1-3/8 - 12	1-3/4 - 12	1-3/4 - 12	1-3/4 - 12
G		1.500 (38.10)	1.500 (38.10)	1.500 (38.10)	1.750 (44.45)	1.750 (44.45)	1.750 (44.45)	2.000 (50.80)	2.000 (50.80)	2.000 (50.80)
J		1.000 (25.40)	1.000 (25.40)	1.000 (25.40)	1.250 (31.75)	1.250 (31.75)	1.250 (31.75)	1.500 (38.10)	1.500 (38.10)	1.500 (38.10)
K		.250 (6.35)	.313 (7.94)	.313 (7.94)	.375 (9.53)	.375 (9.53)	.438 (11.11)	.438 (11.11)	.563 (14.29)	.563 (14.29)
KK	Std.	7/16 - 20	7/16 - 20	7/16 - 20	3/4 - 16	3/4 - 16	3/4 - 16	1 - 14	1 - 14	1 - 14
	O.S.	3/4 - 16	3/4 - 16	3/4 - 16	1 - 14	1 - 14	1 - 14	1-1/4 - 12	1-1/4 - 12	1-1/4 - 12
LB		3.625 (92.08)	3.625 (92.08)	3.750 (95.25)	4.250 (107.95)	4.250 (107.95)	4.500 (114.30)	5.000 (127.00)	5.125 (130.18)	5.125 (130.18)
MM	Std.	.625 (15.88)	.625 (15.88)	.625 (15.88)	1.000 (25.40)	1.000 (25.40)	1.000 (25.40)	1.375 (34.93)	1.375 (34.93)	1.375 (34.93)
	O.S.	1.000 (25.40)	1.000 (25.40)	1.000 (25.40)	1.375 (34.93)	1.375 (34.93)	1.375 (34.93)	1.750 (44.45)	1.750 (44.45)	1.750 (44.45)
NF		1.375 (34.93)	1.375 (34.93)	1.375 (34.93)	1.875 (47.63)	1.875 (47.63)	2.000 (50.80)	2.125 (53.98)	1.813 (46.04)	1.813 (46.04)
P		2.313 (58.74)	2.313 (58.74)	2.438 (61.91)	2.625 (66.68)	2.625 (66.68)	2.875 (73.03)	3.125 (79.38)	3.250 (82.55)	3.250 (82.55)
R		1.428 (36.27)	1.838 (46.68)	2.192 (55.67)	2.758 (70.05)	3.323 (84.40)	4.101 (104.16)	4.879 (123.92)	5.730 (145.54)	6.442 (163.63)
S		1.250 (31.75)	1.750 (44.45)	2.250 (57.15)	2.750 (69.85)	3.500 (88.90)	4.250 (107.95)	5.250 (133.35)	6.125 (155.58)	7.125 (180.98)
SA		6.000 (152.40)	6.000 (152.40)	6.125 (155.58)	7.375 (187.33)	7.375 (187.33)	7.875 (200.03)	8.500 (215.90)	8.750 (222.25)	8.750 (222.25)
VF	Std.	.625 (15.88)	.625 (15.88)	.625 (15.88)	.875 (22.23)	.875 (22.23)	.875 (22.23)	1.000 (25.40)	1.000 (25.40)	1.000 (25.40)
	O.S.	.875 (22.23)	.875 (22.23)	.875 (22.23)	1.000 (25.40)	1.000 (25.40)	1.000 (25.40)	1.125 (28.58)	1.125 (28.58)	1.125 (28.58)
WF	Std.	1.000 (25.40)	1.000 (25.40)	1.000 (25.40)	1.375 (34.93)	1.375 (34.93)	1.375 (34.93)	1.625 (41.28)	1.625 (41.28)	1.625 (41.28)
	O.S.	1.375 (34.93)	1.375 (34.93)	1.375 (34.93)	1.625 (41.28)	1.625 (41.28)	1.625 (41.28)	1.875 (47.63)	1.875 (47.63)	1.875 (47.63)
XA	Std.	5.625 (142.88)	5.438 (138.11)	5.750 (146.05)	6.875 (174.63)	6.875 (174.63)	7.250 (184.15)	8.000 (203.20)	8.562 (217.47)	8.562 (217.47)
	O.S.	6.000 (152.40)	6.000 (152.40)	6.125 (155.58)	7.125 (180.98)	7.125 (180.98)	7.500 (190.50)	8.250 (209.55)	8.813 (223.84)	8.813 (223.84)
Y	Std.	1.875 (47.63)	1.875 (47.63)	1.875 (47.63)	2.438 (61.91)	2.438 (61.91)	2.438 (61.91)	2.813 (71.44)	2.813 (71.44)	2.813 (71.44)
	O.S.	2.250 (57.15)	2.250 (57.15)	2.250 (57.15)	2.688 (68.26)	2.688 (68.26)	2.688 (68.26)	3.063 (77.79)	3.063 (77.79)	3.063 (77.79)

All dimensions in inches (mm)

Code 48 Detachable Eye Mounts (MP4)

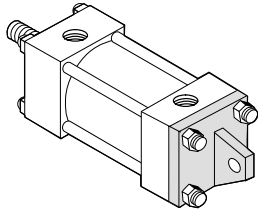

These mounts can be used both in compression (push) and tension (pull). Care must be exercised to prevent rod buckling in compression applications with long strokes.

The centerline of the machine member that attaches to the swivel pin must be perpendicular to the centerline of the piston rod and the curved path must be in one place only. Any misalignment will cause excess side loading on the bearing and piston. This could lead to premature failure.

NOTE

For strokes in excess of 30 inches, see "Stop Tube Selection" on page 45.

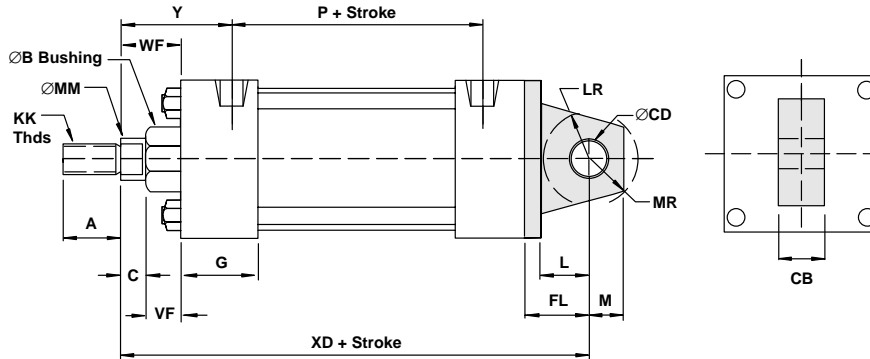

Dimension		1 1/2" Bore (38.10)	2" Bore (50.80)	2 1/2" Bore (63.50)	3 1/4" Bore (82.55)	4" Bore (101.60)	5" Bore (127.00)	6" Bore (152.40)	7" Bore (177.80)	8" Bore (203.20)
Ø Rod	Std.	5/8" (15.88)	5/8" (15.88)	5/8" (15.88)	1" (25.40)	1" (25.40)	1" (25.40)	1-3/8" (34.93)	1-3/8" (34.93)	1-3/8" (34.93)
	O.S.	1" (25.40)	1" (25.40)	1" (25.40)	1-3/8" (34.93)	1-3/8" (34.93)	1-3/8" (34.93)	1-3/4" (44.45)	1-3/4" (44.45)	1-3/4" (44.45)
A	Std.	.750 (19.05)	.750 (19.05)	.750 (19.05)	1.125 (28.58)	1.125 (28.58)	1.125 (28.58)	1.625 (41.28)	1.625 (41.28)	1.625 (41.28)
	O.S.	1.125 (28.58)	1.125 (28.58)	1.125 (28.58)	1.625 (41.28)	1.625 (41.28)	1.625 (41.28)	2.000 (50.80)	2.000 (50.80)	2.000 (50.80)
B+000-002	Std.	1.124 (28.55)	1.124 (28.55)	1.124 (28.55)	1.499 (38.08)	1.499 (38.08)	1.499 (38.08)	1.999 (50.78)	1.999 (50.78)	1.999 (50.78)
	O.S.	1.499 (38.08)	1.499 (38.08)	1.499 (38.08)	1.999 (50.78)	1.999 (50.78)	1.999 (50.78)	2.374 (60.30)	2.374 (60.30)	2.374 (60.30)
C	Std.	.375 (9.53)	.375 (9.53)	.375 (9.53)	.500 (12.70)	.500 (12.70)	.500 (12.70)	.625 (15.88)	.625 (15.88)	.625 (15.88)
	O.S.	.500 (12.70)	.500 (12.70)	.500 (12.70)	.625 (15.88)	.625 (15.88)	.625 (15.88)	.750 (19.05)	.750 (19.05)	.750 (19.05)
CB		.750 (19.05)	.750 (19.05)	.750 (19.05)	1.250 (31.75)	1.250 (31.75)	1.250 (31.75)	1.500 (38.10)	1.500 (38.10)	1.500 (38.10)
CC	Std.	1/2 - 20	1/2 - 20	1/2 - 20	7/8 - 14	7/8 - 14	7/8 - 14	1-1/4 - 12	1-1/4 - 12	1-1/4 - 12
	O.S.	7/8 - 14	7/8 - 14	7/8 - 14	1-1/4 - 12	1-1/4 - 12	1-1/4 - 12	1-1/2 - 12	1-1/2 - 12	1-1/2 - 12
D	Std.	.500 (12.70)	.500 (12.70)	.500 (12.70)	.813 (20.64)	.813 (20.64)	.813 (20.64)	1.125 (28.58)	1.125 (28.58)	1.125 (28.58)
	O.S.	.813 (20.64)	.813 (20.64)	.813 (20.64)	1.125 (28.58)	1.125 (28.58)	1.125 (28.58)	1.500 (38.10)	1.500 (38.10)	1.500 (38.10)
E		2.000 (50.80)	2.500 (63.50)	3.000 (76.20)	3.750 (95.25)	4.500 (114.30)	5.500 (139.70)	6.500 (165.10)	7.500 (190.50)	8.500 (215.90)
EE		.375 (9.53)	.375 (9.53)	.375 (9.53)	.500 (12.70)	.500 (12.70)	.500 (12.70)	.750 (19.05)	.750 (19.05)	.750 (19.05)
FF	Std.	5/8 - 18	5/8 - 18	5/8 - 18	1 - 14	1 - 14	1 - 14	1-3/8 - 12	1-3/8 - 12	1-3/8 - 12
	O.S.	1 - 14	1 - 14	1 - 14	1-3/8 - 12	1-3/8 - 12	1-3/8 - 12	1-3/4 - 12	1-3/4 - 12	1-3/4 - 12
FL		1.125 (28.58)	1.125 (28.58)	1.125 (28.58)	1.875 (47.63)	1.875 (47.63)	1.875 (47.63)	2.250 (57.15)	2.250 (57.15)	2.250 (57.15)
G		1.500 (38.10)	1.500 (38.10)	1.500 (38.10)	1.750 (44.45)	1.750 (44.45)	1.750 (44.45)	2.000 (50.80)	2.000 (50.80)	2.000 (50.80)
J		1.000 (25.40)	1.000 (25.40)	1.000 (25.40)	1.250 (31.75)	1.250 (31.75)	1.250 (31.75)	1.500 (38.10)	1.500 (38.10)	1.500 (38.10)
K		.250 (6.35)	.313 (7.94)	.313 (7.94)	.375 (9.53)	.375 (9.53)	.438 (11.11)	.438 (11.11)	.563 (14.29)	.563 (14.29)
KK	Std.	7/16 - 20	7/16 - 20	7/16 - 20	3/4 - 16	3/4 - 16	3/4 - 16	1 - 14	1 - 14	1 - 14
	O.S.	3/4 - 16	3/4 - 16	3/4 - 16	1 - 14	1 - 14	1 - 14	1-1/4 - 12	1-1/4 - 12	1-1/4 - 12
L		.750 (19.05)	.750 (19.05)	.750 (19.05)	1.250 (31.75)	1.250 (31.75)	1.250 (31.75)	1.500 (38.10)	1.500 (38.10)	1.500 (38.10)
LB		3.625 (92.08)	3.625 (92.08)	3.750 (95.25)	4.250 (107.95)	4.250 (107.95)	4.500 (114.30)	5.000 (127.00)	5.125 (130.18)	5.125 (130.18)
LR		.750 (19.05)	.750 (19.05)	.750 (19.05)	1.250 (31.75)	1.250 (31.75)	1.250 (31.75)	1.500 (38.10)	1.500 (38.10)	1.500 (38.10)
M		.500 (12.70)	.500 (12.70)	.500 (12.70)	.750 (19.05)	.750 (19.05)	.750 (19.05)	1.000 (25.40)	1.000 (25.40)	1.000 (25.40)
MM	Std.	.625 (15.88)	.625 (15.88)	.625 (15.88)	1.000 (25.40)	1.000 (25.40)	1.000 (25.40)	1.375 (34.93)	1.375 (34.93)	1.375 (34.93)
	O.S.	1.000 (25.40)	1.000 (25.40)	1.000 (25.40)	1.375 (34.93)	1.375 (34.93)	1.375 (34.93)	1.750 (44.45)	1.750 (44.45)	1.750 (44.45)
MR		.625 (15.88)	.625 (15.88)	.625 (15.88)	.938 (23.81)	.938 (23.81)	.938 (23.81)	1.188 (30.16)	1.188 (30.16)	1.188 (30.16)
P		2.313 (58.74)	2.313 (58.74)	2.438 (61.91)	2.625 (66.68)	2.625 (66.68)	2.875 (73.03)	3.125 (79.38)	3.250 (82.55)	3.250 (82.55)
VF	Std.	.625 (15.88)	.625 (15.88)	.625 (15.88)	.875 (22.23)	.875 (22.23)	.875 (22.23)	1.000 (25.40)	1.000 (25.40)	1.000 (25.40)
	O.S.	.875 (22.23)	.875 (22.23)	.875 (22.23)	1.000 (25.40)	1.000 (25.40)	1.000 (25.40)	1.125 (28.58)	1.125 (28.58)	1.125 (28.58)
WF	Std.	1.000 (25.40)	1.000 (25.40)	1.000 (25.40)	1.375 (34.93)	1.375 (34.93)	1.375 (34.93)	1.625 (41.28)	1.625 (41.28)	1.625 (41.28)
	O.S.	1.375 (34.93)	1.375 (34.93)	1.375 (34.93)	1.625 (41.28)	1.625 (41.28)	1.625 (41.28)	1.875 (47.63)	1.875 (47.63)	1.875 (47.63)
XD	Std.	5.750 (146.05)	5.750 (146.05)	5.875 (149.23)	7.500 (190.50)	7.500 (190.50)	7.750 (196.85)	8.875 (225.43)	9.000 (228.60)	9.000 (228.60)
	O.S.	6.125 (155.58)	6.125 (155.58)	6.250 (158.75)	7.750 (196.85)	7.750 (196.85)	8.000 (203.20)	9.125 (231.78)	9.250 (234.95)	9.250 (234.95)
Y	Std.	1.875 (47.63)	1.875 (47.63)	1.875 (47.63)	2.438 (61.91)	2.438 (61.91)	2.438 (61.91)	2.813 (71.44)	2.813 (71.44)	2.813 (71.44)
	O.S.	2.250 (57.15)	2.250 (57.15)	2.250 (57.15)	2.688 (68.26)	2.688 (68.26)	2.688 (68.26)	3.063 (77.79)	3.063 (77.79)	3.063 (77.79)

All dimensions in inches (mm)

Code 50 Detachable Clevis (MP2)

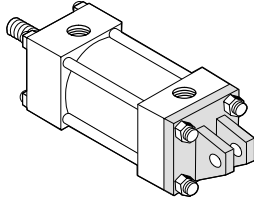

These mounts can be used both in compression (push) and tension (pull). Care must be exercised to prevent rod buckling in compression applications with long strokes.

The centerline of the machine member that attaches to the swivel pin must be perpendicular to the centerline of the piston rod and the curved path must be in one place only. Any misalignment will cause excess side loading on the bearing and piston. This could lead to premature failure.

NOTE

For strokes in excess of 30 inches, see "Stop Tube Selection" on page 45.

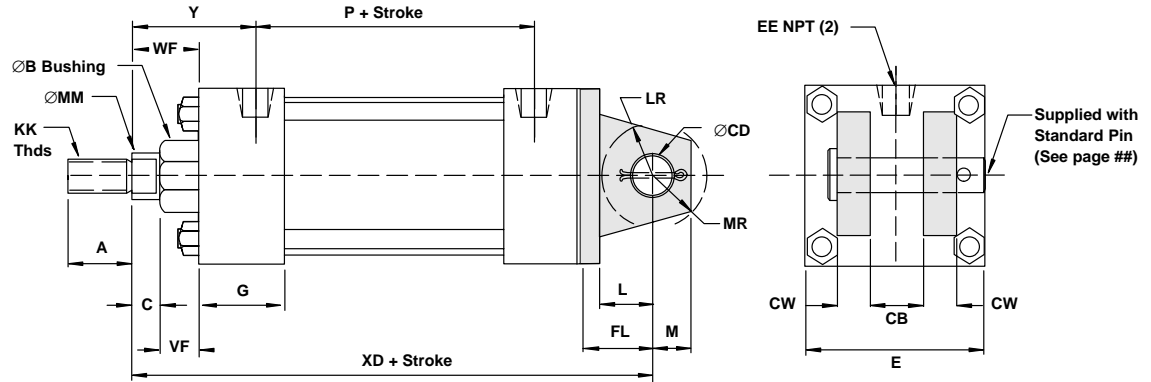

Dimension		1 1/2" Bore (38.10)	2" Bore (50.80)	2 1/2" Bore (63.50)	3 1/4" Bore (82.55)	4" Bore (101.60)	5" Bore (127.00)	6" Bore (152.40)	7" Bore (177.80)	8" Bore (203.20)
Ø Rod	Std.	5/8" (15.88)	5/8" (15.88)	5/8" (15.88)	1" (25.40)	1" (25.40)	1" (25.40)	1-3/8" (34.93)	1-3/8" (34.93)	1-3/8" (34.93)
	O.S.	1" (25.40)	1" (25.40)	1" (25.40)	1-3/8" (34.93)	1-3/8" (34.93)	1-3/8" (34.93)	1-3/4" (44.45)	1-3/4" (44.45)	1-3/4" (44.45)
A	Std.	.750 (19.05)	.750 (19.05)	.750 (19.05)	1.125 (28.58)	1.125 (28.58)	1.125 (28.58)	1.625 (41.28)	1.625 (41.28)	1.625 (41.28)
	O.S.	1.125 (28.58)	1.125 (28.58)	1.125 (28.58)	1.625 (41.28)	1.625 (41.28)	1.625 (41.28)	2.000 (50.80)	2.000 (50.80)	2.000 (50.80)
B+.000 -.002	Std.	1.124 (28.55)	1.124 (28.55)	1.124 (28.55)	1.499 (38.08)	1.499 (38.08)	1.499 (38.08)	1.999 (50.78)	1.999 (50.78)	1.999 (50.78)
	O.S.	1.499 (38.08)	1.499 (38.08)	1.499 (38.08)	1.999 (50.78)	1.999 (50.78)	1.999 (50.78)	2.374 (60.30)	2.374 (60.30)	2.374 (60.30)
C	Std.	.375 (9.53)	.375 (9.53)	.375 (9.53)	.500 (12.70)	.500 (12.70)	.500 (12.70)	.625 (15.88)	.625 (15.88)	.625 (15.88)
	O.S.	.500 (12.70)	.500 (12.70)	.500 (12.70)	.625 (15.88)	.625 (15.88)	.625 (15.88)	.750 (19.05)	.750 (19.05)	.750 (19.05)
CB		.750 (19.05)	.750 (19.05)	.750 (19.05)	1.250 (31.75)	1.250 (31.75)	1.250 (31.75)	1.500 (38.10)	1.500 (38.10)	1.500 (38.10)
CC	Std.	1/2 - 20	1/2 - 20	1/2 - 20	7/8 - 14	7/8 - 14	7/8 - 14	1-1/4 - 12	1-1/4 - 12	1-1/4 - 12
	O.S.	7/8 - 14	7/8 - 14	7/8 - 14	1-1/4 - 12	1-1/4 - 12	1-1/4 - 12	1-1/2 - 12	1-1/2 - 12	1-1/2 - 12
CD		.500 (12.70)	.500 (12.70)	.500 (12.70)	.750 (19.05)	.750 (19.05)	.750 (19.05)	1.000 (25.40)	1.000 (25.40)	1.000 (25.40)
CW		.500 (12.70)	.500 (12.70)	.500 (12.70)	.625 (15.88)	.625 (15.88)	.625 (15.88)	.750 (19.05)	.750 (19.05)	.750 (19.05)
D	Std.	.500 (12.70)	.500 (12.70)	.500 (12.70)	.813 (20.64)	.813 (20.64)	.813 (20.64)	1.125 (28.58)	1.125 (28.58)	1.125 (28.58)
	O.S.	.813 (20.64)	.813 (20.64)	.813 (20.64)	1.125 (28.58)	1.125 (28.58)	1.125 (28.58)	1.500 (38.10)	1.500 (38.10)	1.500 (38.10)
E		2.000 (50.80)	2.500 (63.50)	3.000 (76.20)	3.750 (95.25)	4.500 (114.30)	5.500 (139.70)	6.500 (165.10)	7.500 (190.50)	8.500 (215.90)
EE		.375 (9.53)	.375 (9.53)	.375 (9.53)	.500 (12.70)	.500 (12.70)	.500 (12.70)	.750 (19.05)	.750 (19.05)	.750 (19.05)
FF	Std.	5/8 - 18	5/8 - 18	5/8 - 18	1 - 14	1 - 14	1 - 14	1-3/8 - 12	1-3/8 - 12	1-3/8 - 12
	O.S.	1 - 14	1 - 14	1 - 14	1-3/8 - 12	1-3/8 - 12	1-3/8 - 12	1-3/4 - 12	1-3/4 - 12	1-3/4 - 12
FL		1.125 (28.58)	1.125 (28.58)	1.125 (28.58)	1.875 (47.63)	1.875 (47.63)	1.875 (47.63)	2.250 (57.15)	2.250 (57.15)	2.250 (57.15)
G		1.500 (38.10)	1.500 (38.10)	1.500 (38.10)	1.750 (44.45)	1.750 (44.45)	1.750 (44.45)	2.000 (50.80)	2.000 (50.80)	2.000 (50.80)
J		1.000 (25.40)	1.000 (25.40)	1.000 (25.40)	1.250 (31.75)	1.250 (31.75)	1.250 (31.75)	1.500 (38.10)	1.500 (38.10)	1.500 (38.10)
K		.250 (6.35)	.313 (7.94)	.313 (7.94)	.375 (9.53)	.375 (9.53)	.438 (11.11)	.438 (11.11)	.563 (14.29)	.563 (14.29)
KK	Std.	7/16 - 20	7/16 - 20	7/16 - 20	3/4 - 16	3/4 - 16	3/4 - 16	1 - 14	1 - 14	1 - 14
	O.S.	3/4 - 16	3/4 - 16	3/4 - 16	1 - 14	1 - 14	1 - 14	1-1/4 - 12	1-1/4 - 12	1-1/4 - 12
L		.750 (19.05)	.750 (19.05)	.750 (19.05)	1.250 (31.75)	1.250 (31.75)	1.250 (31.75)	1.500 (38.10)	1.500 (38.10)	1.500 (38.10)
LB		3.625 (92.08)	3.625 (92.08)	3.750 (95.25)	4.250 (107.95)	4.250 (107.95)	4.500 (114.30)	5.000 (127.00)	5.125 (130.18)	5.125 (130.18)
LR		.750 (19.05)	.750 (19.05)	.750 (19.05)	1.250 (31.75)	1.250 (31.75)	1.250 (31.75)	1.500 (38.10)	1.500 (38.10)	1.500 (38.10)
M		.500 (12.70)	.500 (12.70)	.500 (12.70)	.750 (19.05)	.750 (19.05)	.750 (19.05)	1.000 (25.40)	1.000 (25.40)	1.000 (25.40)
MM	Std.	.625 (15.88)	.625 (15.88)	.625 (15.88)	1.000 (25.40)	1.000 (25.40)	1.000 (25.40)	1.375 (34.93)	1.375 (34.93)	1.375 (34.93)
	O.S.	1.000 (25.40)	1.000 (25.40)	1.000 (25.40)	1.375 (34.93)	1.375 (34.93)	1.375 (34.93)	1.750 (44.45)	1.750 (44.45)	1.750 (44.45)
MR		.625 (15.88)	.625 (15.88)	.625 (15.88)	.938 (23.81)	.938 (23.81)	.938 (23.81)	1.188 (30.16)	1.188 (30.16)	1.188 (30.16)
P		2.313 (58.74)	2.313 (58.74)	2.438 (61.91)	2.625 (66.68)	2.625 (66.68)	2.875 (73.03)	3.125 (79.38)	3.250 (82.55)	3.250 (82.55)
VF	Std.	.625 (15.88)	.625 (15.88)	.625 (15.88)	.875 (22.23)	.875 (22.23)	.875 (22.23)	1.000 (25.40)	1.000 (25.40)	1.000 (25.40)
	O.S.	.875 (22.23)	.875 (22.23)	.875 (22.23)	1.000 (25.40)	1.000 (25.40)	1.000 (25.40)	1.125 (28.58)	1.125 (28.58)	1.125 (28.58)
WF	Std.	1.000 (25.40)	1.000 (25.40)	1.000 (25.40)	1.375 (34.93)	1.375 (34.93)	1.375 (34.93)	1.625 (41.28)	1.625 (41.28)	1.625 (41.28)
	O.S.	1.375 (34.93)	1.375 (34.93)	1.375 (34.93)	1.625 (41.28)	1.625 (41.28)	1.625 (41.28)	1.875 (47.63)	1.875 (47.63)	1.875 (47.63)
XD	Std.	5.750 (146.05)	5.750 (146.05)	5.875 (149.23)	7.500 (190.50)	7.500 (190.50)	7.750 (196.85)	8.875 (225.43)	9.000 (228.60)	9.000 (228.60)
	O.S.	6.125 (155.58)	6.125 (155.58)	6.250 (158.75)	7.750 (196.85)	7.750 (196.85)	8.000 (203.20)	9.125 (231.78)	9.250 (234.95)	9.250 (234.95)
Y	Std.	1.875 (47.63)	1.875 (47.63)	1.875 (47.63)	2.438 (61.91)	2.438 (61.91)	2.438 (61.91)	2.813 (71.44)	2.813 (71.44)	2.813 (71.44)
	O.S.	2.250 (57.15)	2.250 (57.15)	2.250 (57.15)	2.688 (68.26)	2.688 (68.26)	2.688 (68.26)	3.063 (77.79)	3.063 (77.79)	3.063 (77.79)

All dimensions in inches (mm)

Accessories for 1-1/2 thru 8 inch Bore Cylinders

NFPA Rod Clevis

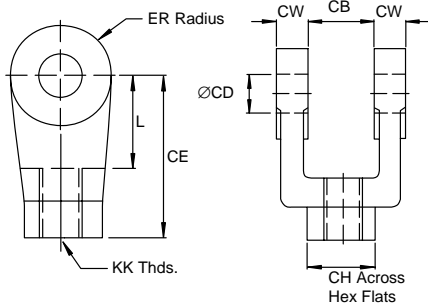

	VP62008A	VP62008B	VP6200CA	VP62010A	VP62016A
CB	.750 (19.05)	.750 (19.05)	1.250 (31.75)	1.500 (38.10)	2.000 (50.80)
CD	.500 (12.70)	.500 (12.70)	.750 (19.05)	1.000 (25.40)	1.375 (60.33)
CE	1.500 (38.10)	1.500 (38.10)	2.375 (60.33)	3.125 (79.38)	4.125 (104.78)
CH	1.000 (25.40)	1.000 (25.40)	1.250 (31.75)	1.500 (38.10)	2.000 (50.80)
CW	.500 (12.70)	.500 (12.70)	.625 (15.88)	.750 (19.05)	1.000 (25.40)
ER	.500 (12.70)	.500 (12.70)	.750 (19.05)	1.000 (25.40)	1.375 (60.33)
KK	7/16-20	1/2-20	3/4-16	1-14	1-1/4-12
L	.750 (19.05)	.750 (19.05)	1.250 (31.75)	1.500 (38.10)	2.125 (53.98)

Small Rod Clevis & Jam Nut

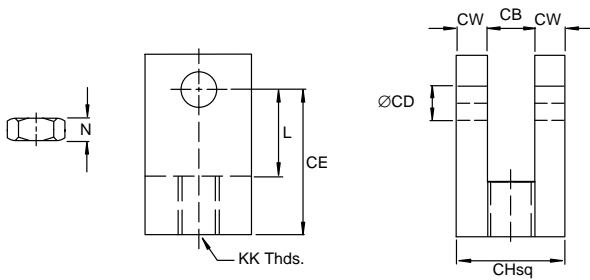

	VP62008C	VP6200CC
CB	.500 (12.70)	.750 (19.05)
CD	.500 (12.70)	.750 (19.05)
CE	1.375 (34.93)	1.750 (44.45)
CH	1.000 (25.40)	1.500 (38.10)
CW	.250 (6.35)	.375 (9.53)
KK	1/2-20	3/4-16
L	.750 (19.05)	1.000 (25.40)
N	.375 (9.53)	.500 (12.70)

NFPA Rod Eye

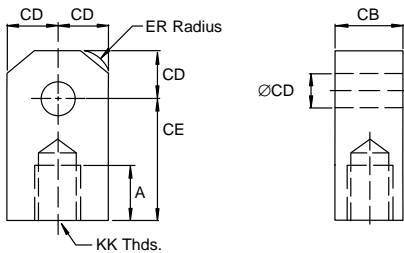

	VP60008A	VP60008C	VP6000CA	VP60010A	VP60016A
CB	.750 (19.05)	.750 (19.05)	1.250 (31.75)	1.500 (38.10)	2.000 (50.80)
CD	.500 (12.70)	.500 (12.70)	.750 (19.05)	1.000 (25.40)	1.375 (60.33)
CE	1.500 (38.10)	1.500 (38.10)	2.375 (60.33)	3.125 (79.38)	4.125 (104.78)
ER	.500 (12.70)	.500 (12.70)	.750 (19.05)	1.000 (25.40)	1.375 (60.33)
L	.750 (19.05)	.750 (19.05)	1.250 (31.75)	1.500 (38.10)	2.125 (53.98)

Spherical Rod Eye

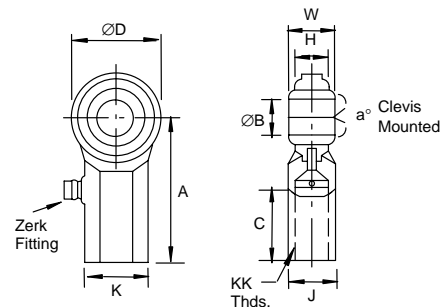

	VP62008C	VP6200CC	VP60010B	
Bore	1-1/2 & 2-1/2	3-1/4, 4 & 5	6 & 8	
a°	Misalign. Angle	12	14	
A	± .015	2.125 (53.98)	2.875 (73.03)	4.125 (104.78)
B	+ .0025 / - .0005	.500 (12.70)	.750 (19.05)	1.000 (25.40)
C	+ .062 / - .031	1.062 (26.97)	1.562 (39.67)	2.125 (53.98)
D	± .010	1.312 (33.32)	1.750 (44.45)	2.750 (69.85)
H	REF.	.453 (11.51)	.593 (15.06)	1.000 (25.40)
J	± .010	.750 (19.05)	1.000 (25.40)	1.500 (38.10)
K	± .010	.875 (22.23)	1.125 (28.58)	1.625 (41.28)
KK	UNF-2B	1/2-20	3/4-16	1-14
W	+ .000 / - .005	.625 (15.88)	.875 (22.23)	1.375 (34.93)

NFPA Eye Bracket

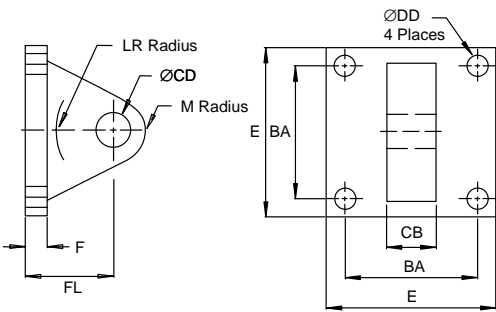

	VP62008A	VP62008B	VP6200CA	VP62010A
BA	1.625 (41.28)	2.562 (65.07)	3.250 (82.55)	3.812 (96.82)
CB	.750 (19.05)	1.250 (31.75)	1.500 (38.10)	2.000 (50.80)
CD	.500 (12.70)	.750 (19.05)	1.000 (25.40)	1.375 (60.33)
DD	.406 (10.31)	.531 (13.49)	.656 (16.66)	.656 (16.66)
E	2.500 (63.50)	3.500 (88.90)	4.500 (114.30)	5.000 (127.00)
F	.375 (9.53)	.625 (15.88)	.750 (19.05)	.875 (22.23)
FL	1.125 (28.58)	1.875 (47.63)	2.250 (57.15)	3.000 (76.20)
LR	.750 (19.05)	1.250 (31.75)	1.500 (38.10)	2.125 (53.98)

Alternate Eye Bracket

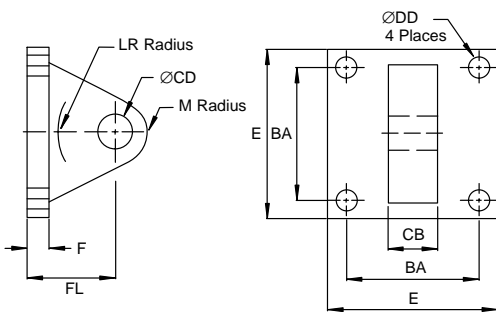

	VP78008B	VP78008C	VP78008D	VP7800CB	VP7800CC
BA	1.437 (36.50)	1.844 (46.84)	2.187 (55.55)	2.937 (74.60)	3.562 (90.47)
CB	.750 (19.05)	.750 (19.05)	.750 (19.05)	1.250 (31.75)	1.250 (31.75)
CD	.500 (12.70)	.500 (12.70)	.500 (12.70)	.750 (19.05)	.750 (19.05)
DD	.281 (7.14)	.343 (8.71)	.343 (8.71)	.469 (11.91)	.469 (11.91)
E	2.000 (50.80)	2.500 (63.50)	3.000 (76.20)	3.750 (95.25)	4.500 (114.30)
F	.375 (9.53)	.375 (9.53)	.375 (9.53)	.500 (12.70)	.500 (12.70)
FL	1.125 (28.58)	1.125 (28.58)	1.125 (28.58)	1.750 (44.45)	1.750 (44.45)
LR	.562 (14.27)	.562 (14.27)	.562 (14.27)	1.000 (25.40)	1.000 (25.40)
M	.625 (15.88)	.625 (15.88)	.625 (15.88)	.875 (22.23)	.875 (22.23)

NFPA Clevis Bracket

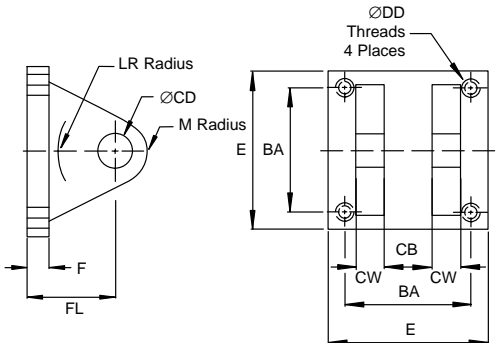

	VP61008A	VP6100CA	VP61010A
BA	1.625 (41.28)	2.562 (65.07)	3.250 (82.55)
CB	.750 (19.05)	1.250 (31.75)	1.500 (38.10)
CD	.500 (12.70)	.750 (19.05)	1.000 (25.40)
CW	.500 (12.70)	.625 (15.88)	.750 (19.05)
DD	3/8 - 24	1/2 - 20	5/8 - 18
E	2.500 (63.50)	3.500 (88.90)	4.500 (114.30)
F	.375 (9.53)	.625 (15.88)	.750 (19.05)
FL	1.125 (28.58)	1.875 (47.63)	2.250 (57.15)
LR	.750 (19.05)	1.250 (31.75)	1.500 (38.10)
M	.500 (12.70)	.812 (20.62)	1.000 (25.40)

NFPA Pin

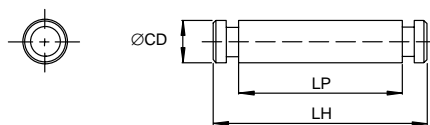

	VP83008A	VP8300CA	VP83010A
CD	.500 (12.70)	.750 (19.05)	1.000 (25.40)
LH	2.219 (56.36)	3.125 (79.38)	3.750 (95.25)
LP	1.875 (47.63)	2.750 (69.85)	3.250 (82.55)

Alternate Eye Bracket

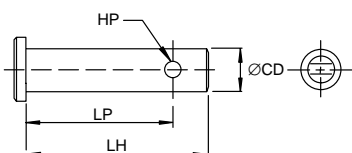

	VP83008B	VP83008C	VP83008CB	VP8300CC	VP83010B	VP83016B
CD	.500 (12.70)	.500 (12.70)	.750 (19.05)	.750 (19.05)	1.000 (25.40)	1.375 (34.93)
HP	.156 (3.96)	.156 (3.96)	.156 (3.96)	.156 (3.96)	.203 (5.16)	.250 (6.35)
LH	1.421 (36.09)	2.250 (57.15)	2.000 (50.80)	3.000 (76.20)	3.500 (88.90)	5.000 (127.00)
LP	1.266 (32.16)	2.093 (53.16)	1.843 (46.81)	2.843 (72.21)	3.297 (83.74)	4.500 (114.30)

All dimensions in inches (mm)

Rod Alignment Coupler

The Rod Alignment Coupler allows 1/16 inch of radial float and 2° of spherical movement. This prevents cylinder binding due to misalignment thus extending bearing and seal life, and permits greater tolerance between the centerline of the cylinder and mating part for simplified installation.

NOTE

A Rod Alignment Coupler is not recommended for unguided loads.

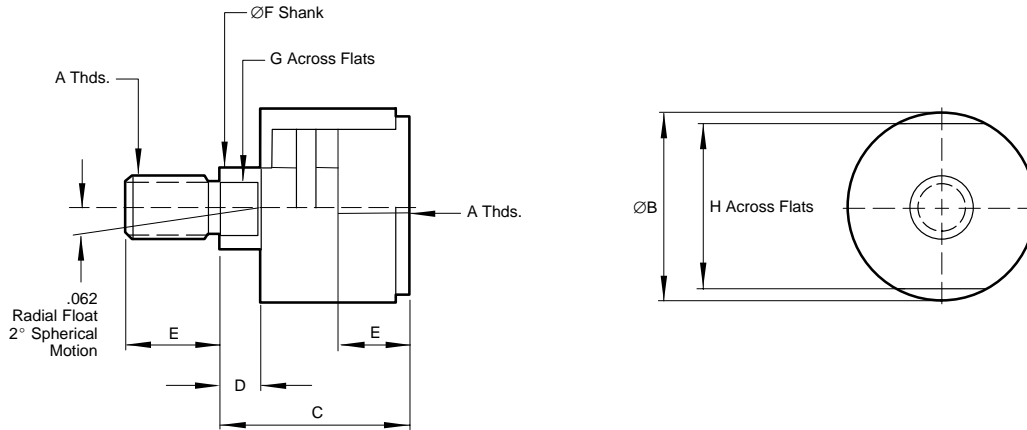

	7756A-1/4-28	7756A-5/16-24	7756A-3/8-24	7756A-7/16-20	7756A-1/2-20	7756A-5/8-18	7756A-3/4-16	7756A-7/8-14	7756A-1-14	7756A-1-1/4-12	7756A-1-1/2-12	7756A-1-3/4-12
A	1/4 - 28	5/16 - 24	3/8 - 24	7/16 - 20	1/2 - 20	5/8 - 18	3/4 - 16	7/8 - 14	1 - 14	1-1/4 - 12	1-1/2 - 12	1-3/4 - 12
B	.875 (22.23)	.875 (22.23)	.875 (22.23)	1.250 (31.75)	1.250 (31.75)	1.250 (31.75)	1.750 (44.45)	1.750 (44.45)	2.500 (63.50)	2.500 (63.50)	3.250 (82.50)	3.250 (82.50)
C	1.250 (31.75)	1.250 (31.75)	1.250 (31.75)	2.000 (50.80)	2.000 (50.80)	2.000 (50.80)	2.312 (58.72)	2.312 (58.72)	2.937 (74.60)	2.937 (74.60)	4.375 (111.13)	4.375 (111.13)
D	.250 (6.35)	.250 (6.35)	.250 (6.35)	.500 (12.70)	.500 (12.70)	.500 (12.70)	.500 (12.70)	.500 (12.70)	.500 (12.70)	.500 (12.70)	.812 (20.62)	.812 (20.62)
E	.625 (15.88)	.625 (15.88)	.625 (15.88)	.750 (19.05)	.750 (19.05)	.750 (19.05)	1.125 (28.58)	1.125 (28.58)	1.625 (41.28)	1.625 (41.28)	2.250 (57.15)	2.250 (57.15)
F	.312 (7.92)	.312 (7.92)	.375 (9.53)	.625 (15.88)	.625 (15.88)	.625 (15.88)	.969 (24.61)	.969 (24.61)	1.375 (34.93)	1.375 (34.93)	1.750 (44.45)	1.750 (44.45)
G	.187 (4.75)	.250 (6.35)	.312 (7.92)	.500 (12.70)	.500 (12.70)	.500 (12.70)	.812 (20.62)	.812 (20.62)	1.156 (29.36)	1.156 (29.36)	1.500 (38.10)	1.500 (38.10)
H	.750 (19.05)	.750 (19.05)	.750 (19.05)	1.125 (28.58)	1.125 (28.58)	1.125 (28.58)	1.500 (38.10)	1.500 (38.10)	2.250 (57.15)	2.250 (57.15)	3.000 (76.20)	3.000 (76.20)
Max Pull lbs. (kg)	1,500 (680)	2,075 (941)	2,075 (941)	2,500 (1134)	3,500 (1588)	4,750 (2155)	8,500 (3856)	9,750 (4423)	16,000 (7258)	19,500 (8845)	33,500 (15196)	33,500 (15196)

Optional Rod Ends for 1-1/2 thru 8 inch Bore Cylinders

Rod End Types

In addition to selecting the correct bore, you must specify the appropriate rod size and rod end configuration for your application.

Five different inch rod end configurations are available. If a custom design is required, contact your local Vickers sales engineer, and define your requirements.

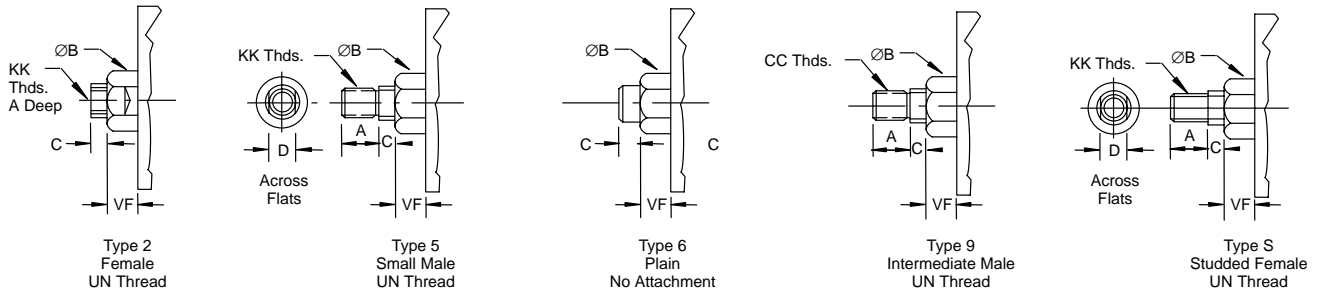

Dimension		1 1/2" Bore (38.10)	2" Bore (50.80)	2 1/2" Bore (63.50)	3 1/4" Bore (82.55)	4" Bore (101.60)	5" Bore (127.00)	6" Bore (152.40)	7" Bore (177.80)	8" Bore (203.20)
Ø Rod	Std.	5/8" (15.88)	5/8" (15.88)	5/8" (15.88)	1" (25.40)	1" (25.40)	1" (25.40)	1-3/8" (34.93)	1-3/8" (34.93)	1-3/8" (34.93)
	O.S.	1" (25.40)	1" (25.40)	1" (25.40)	1-3/8" (34.93)	1-3/8" (34.93)	1-3/8" (34.93)	1-3/4" (44.45)	1-3/4" (44.45)	1-3/4" (44.45)
A	Std.	.750 (19.05)	.750 (19.05)	.750 (19.05)	1.125 (28.58)	1.125 (28.58)	1.125 (28.58)	1.625 (41.28)	1.625 (41.28)	1.625 (41.28)
	O.S.	1.125 (28.58)	1.125 (28.58)	1.125 (28.58)	1.625 (41.28)	1.625 (41.28)	1.625 (41.28)	2.000 (50.80)	2.000 (50.80)	2.000 (50.80)
B ^{+0.000} -0.002	Std.	1.124 (28.55)	1.124 (28.55)	1.124 (28.55)	1.499 (38.08)	1.499 (38.08)	1.499 (38.08)	1.999 (50.78)	1.999 (50.78)	1.999 (50.78)
	O.S.	1.499 (38.08)	1.499 (38.08)	1.499 (38.08)	1.999 (50.78)	1.999 (50.78)	1.999 (50.78)	2.374 (60.30)	2.374 (60.30)	2.374 (60.30)
C	Std.	.375 (9.53)	.375 (9.53)	.375 (9.53)	.500 (12.70)	.500 (12.70)	.500 (12.70)	.625 (15.88)	.625 (15.88)	.625 (15.88)
	O.S.	.500 (12.70)	.500 (12.70)	.500 (12.70)	.625 (15.88)	.625 (15.88)	.625 (15.88)	.750 (19.05)	.750 (19.05)	.750 (19.05)
CC	Std.	1/2 - 20	1/2 - 20	1/2 - 20	7/8 - 14	7/8 - 14	7/8 - 14	1-1/4 - 12	1-1/4 - 12	1-1/4 - 12
	O.S.	7/8 - 14	7/8 - 14	7/8 - 14	1-1/4 - 12	1-1/4 - 12	1-1/4 - 12	1-1/2 - 12	1-1/2 - 12	1-1/2 - 12
D	Std.	.500 (12.70)	.500 (12.70)	.500 (12.70)	.813 (20.64)	.813 (20.64)	.813 (20.64)	1.125 (28.58)	1.125 (28.58)	1.125 (28.58)
	O.S.	.813 (20.64)	.813 (20.64)	.813 (20.64)	1.125 (28.58)	1.125 (28.58)	1.125 (28.58)	1.500 (38.10)	1.500 (38.10)	1.500 (38.10)
KK	Std.	7/16 - 20	7/16 - 20	7/16 - 20	3/4 - 16	3/4 - 16	3/4 - 16	1 - 14	1 - 14	1 - 14
	O.S.	3/4 - 16	3/4 - 16	3/4 - 16	1 - 14	1 - 14	1 - 14	1-1/4 - 12	1-1/4 - 12	1-1/4 - 12
VF	Std.	.625 (15.88)	.625 (15.88)	.625 (15.88)	.875 (22.23)	.875 (22.23)	.875 (22.23)	1.000 (25.40)	1.000 (25.40)	1.000 (25.40)
	O.S.	.875 (22.23)	.875 (22.23)	.875 (22.23)	1.000 (25.40)	1.000 (25.40)	1.000 (25.40)	1.125 (28.58)	1.125 (28.58)	1.125 (28.58)

All dimensions in inches (mm)

3/4 & 1-1/8 inch Bore Cylinders and Mounts

Code 01 Bolt Thru Mounts (ANSI MS8)

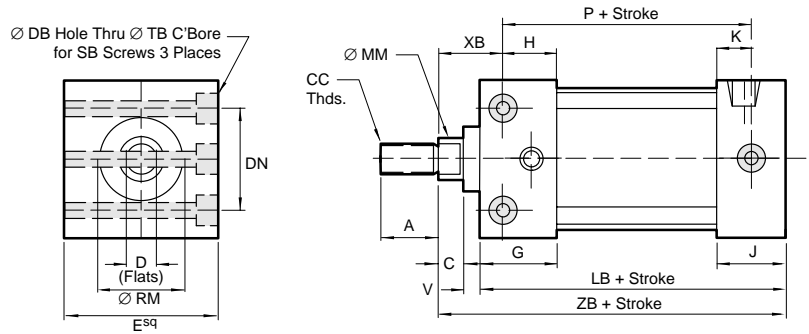
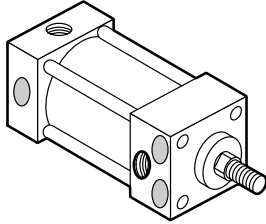

Code 02 Tapped Mounts (ANSI MS9)

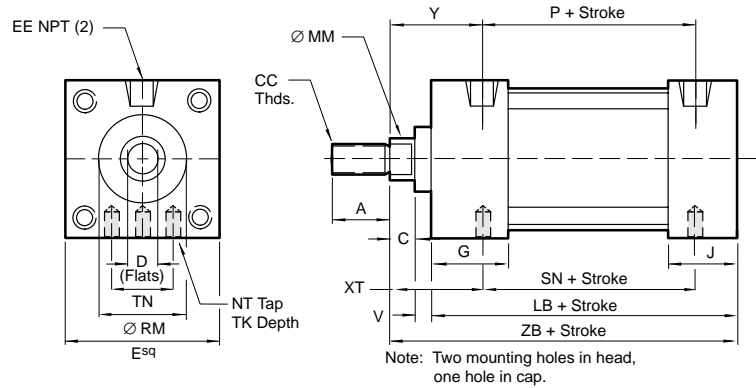
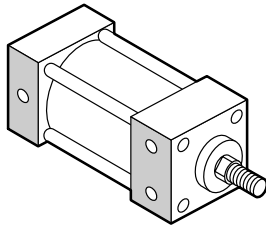

Code 07 Head Rectangular Flange Mounts (ANSI MF1)

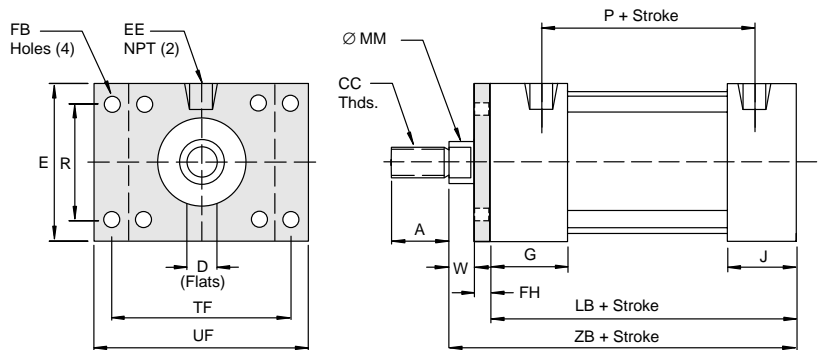
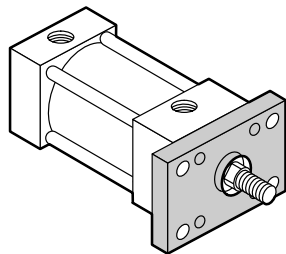

Dimension		01 Bolt Thru Mounts (MS8)		02 Bolt Thru Mounts (MS8)		07 Head Rect. Flange Mounts (MF1)	
		3/4"	1-1/8"	3/4"	1-1/8"	3/4"	1-1/8"
Ø Rod	Std.	.312 (7.92)	.375 (9.53)	.312 (7.92)	.375 (9.53)	.312 (7.92)	.375 (9.53)
	O.S.	–	.500 (12.70)	–	.500 (12.70)	–	.500 (12.70)
A	Std.	.625 (15.88)	.625 (15.88)	.625 (15.88)	.625 (15.88)	.625 (15.88)	.625 (15.88)
	O.S.	–	.750 (19.05)	–	.750 (19.05)	–	.750 (19.05)
C		.250 (6.35)	.250 (6.35)	.250 (6.35)	.250 (6.35)	.250 (6.35)	.250 (6.35)
CC	Std.	1/4 – 28	3/8 – 24	1/4 – 28	3/8 – 24	1/4 – 28	3/8 – 24
	O.S.	–	1/2 – 20	–	1/2 – 20	–	1/2 – 20
D	Std.	.250 (6.35)	.312 (7.92)	.250 (6.35)	.312 (7.92)	.250 (6.35)	.312 (7.92)
	O.S.	–	.437 (11.10)	–	.437 (11.10)	–	.437 (11.10)
DB		.172 (4.37)	.203 (5.16)	–	–	–	–
DN		.625 (15.88)	1.000 (25.40)	–	–	–	–
E		1.000 (25.40)	1.500 (38.10)	1.000 (25.40)	1.500 (38.10)	–	–
EE		.125 (3.18)	.125 (3.18)	.125 (3.18)	.125 (3.18)	–	–
FB		–	–	–	–	.219 (5.56)	.219 (5.56)
FH		–	–	–	–	.250 (6.35)	.250 (6.35)
G		.875 (22.23)	.875 (22.23)	.875 (22.23)	.875 (22.23)	.875 (22.23)	.875 (22.23)
H		.687 (17.45)	.625 (15.88)	–	–	–	–
J		.625 (15.88)	.625 (15.88)	.625 (15.88)	.625 (15.88)	.625 (15.88)	.625 (15.88)
K		.375 (9.53)	.375 (9.53)	–	–	–	–
LB		2.250 (57.15)	2.250 (57.15)	2.250 (57.15)	2.250 (57.15)	2.250 (57.15)	2.250 (57.15)
MM	Std.	.307 (7.80)	.307 (7.80)	.307 (7.80)	.307 (7.80)	.307 (7.80)	.307 (7.80)
	O.S.	–	.495 (12.57)	–	.495 (12.57)	–	.495 (12.57)
NT		–	–	8 – 32	10 – 32	–	–
P		–	–	1.375 (34.93)	1.375 (34.93)	1.375 (34.93)	1.375 (34.93)
R		–	–	–	–	.500 (12.70)	1.000 (25.40)
RM	Std.	.562 (14.27)	.750 (19.05)	.562 (14.27)	.750 (19.05)	–	–
	O.S.	–	1.000 (25.40)	–	1.000 (25.40)	–	–
SB		#8	#10	–	–	–	–
SN		–	–	1.812 (46.02)	1.750 (44.45)	–	–
TB		.281 (7.14)	.328 (8.33)	–	–	–	–
TF		–	–	–	–	1.500 (38.10)	2.000 (56.80)
TK		–	–	.187 (4.87)	.250 (6.35)	–	–
TN		–	–	.625 (15.88)	1.000 (25.40)	–	–
UF		–	–	–	–	2.000 (56.80)	2.500 (63.50)
V		.125 (3.18)	.125 (3.18)	.125 (3.18)	.125 (3.18)	.125 (3.18)	.125 (3.18)
XT		–	–	.562 (14.27)	.625 (15.88)	–	–
W		–	–	–	–	.125 (3.18)	.125 (3.18)
XB		.562 (14.27)	.625 (15.88)	–	–	–	–
Y		–	–	.938 (23.83)	.938 (23.83)	.938 (23.83)	.938 (23.83)
ZB		–	–	2.625 (66.68)	2.625 (66.68)	2.625 (66.68)	2.625 (66.68)

All dimensions in inches (mm)

3/4 & 1-1/8 inch Bore Cylinders and Mounts

Code 12 Cap Rectangular Flange Mounts (ANSI MF2)

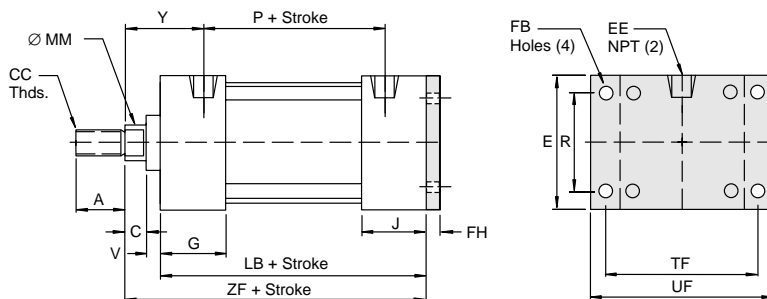
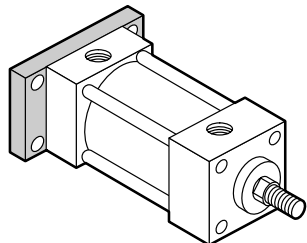

Code 18 Head Tapped Face Mounts (ANSI MR1)

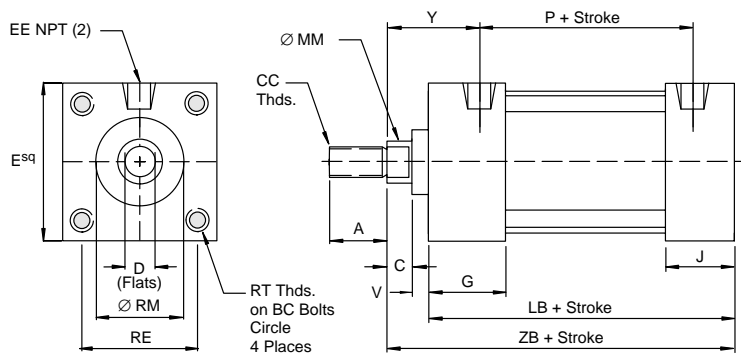
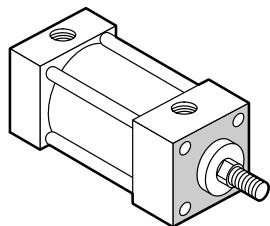

Code 20 Threaded Nose Mounts (ANSI MNR1)

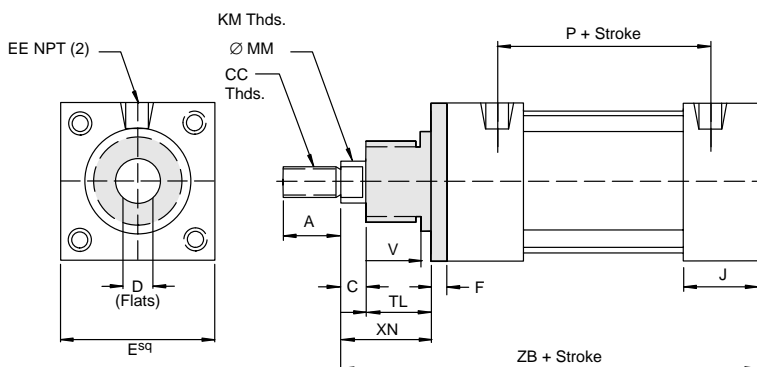
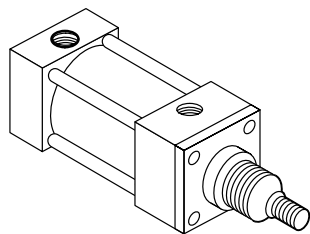

Dimension		12 Cap. Rect. Flange Mounts (MF2)		18 Head Tapped Face Mounts (MR1)		20 Threaded Nose Mounts (MNR1)	
		3/4"	1-1/8"	3/4"	1-1/8"	3/4"	1-1/8"
Ø Rod	Std.	.312 (7.92)	.375 (9.53)	.312 (7.92)	.375 (9.53)	.312 (7.92)	.375 (9.53)
	O.S.	–	.500 (12.70)	–	.500 (12.70)	–	.500 (12.70)
A	Std.	.625 (15.88)	.625 (15.88)	.625 (15.88)	.625 (15.88)	.625 (15.88)	.625 (15.88)
	O.S.	–	.750 (19.05)	–	.750 (19.05)	–	.750 (19.05)
C		.250 (6.35)	.250 (6.35)	.250 (6.35)	.250 (6.35)	.250 (6.35)	.250 (6.35)
CC	Std.	1/4 – 28	3/8 – 24	1/4 – 28	3/8 – 24	1/4 – 28	3/8 – 24
	O.S.	–	1/2 – 20	–	1/2 – 20	–	1/2 – 20
D	Std.	–	–	.250 (6.35)	.312 (7.92)	.250 (6.35)	.312 (7.92)
	O.S.	–	–	–	.437 (11.10)	–	.437 (11.10)
E		1.000 (25.40)	1.500 (38.10)	1.000 (25.40)	1.500 (38.10)	1.000 (25.40)	1.500 (38.10)
EE		.125 (3.18)	.125 (3.18)	.125 (3.18)	.125 (3.18)	.125 (3.18)	.125 (3.18)
F		–	–	–	–	.250 (6.35)	.250 (6.35)
FB		.219 (5.56)	.219 (5.56)	–	–	–	–
FH		.250 (6.35)	.250 (6.35)	–	–	–	–
G		.875 (22.23)	.875 (22.23)	.875 (22.23)	.875 (22.23)	.875 (22.23)	.875 (22.23)
J		.625 (15.88)	.625 (15.88)	.625 (15.88)	.625 (15.88)	.625 (15.88)	.625 (15.88)
KM		–	–	–	–	5/8 – 18	1 – 14
LB		2.250 (57.15)	2.250 (57.15)	2.250 (57.15)	2.250 (57.15)	2.250 (57.15)	2.250 (57.15)
MM	Std.	.307 (7.80)	.370 (9.40)	.307 (7.80)	.370 (9.40)	.307 (7.80)	.370 (9.40)
	O.S.	–	.495 (12.57)	–	.495 (12.57)	–	.495 (12.57)
P		1.375 (34.93)	1.375 (34.93)	1.375 (34.93)	1.375 (34.93)	1.375 (34.93)	1.375 (34.93)
R		.500 (12.70)	1.000 (25.40)	–	–	–	–
RE		.750 (19.05)	1.125 (28.58)	.750 (19.05)	1.125 (28.58)	–	–
RM	Std.	–	–	.625 (15.88)	.750 (19.05)	.625 (15.88)	1.062 (26.97)
	O.S.	–	–	–	–	–	–
RT		–	–	8 – 32	10 – 32	–	–
TF		1.500 (38.10)	2.000 (50.80)	–	–	–	–
TL		–	–	–	–	.625 (15.88)	.875 (22.23)
UF		2.000 (50.80)	2.500 (63.50)	–	–	–	–
V		.125 (3.18)	.125 (3.18)	.125 (3.18)	.125 (3.18)	.125 (3.18)	.125 (3.18)
XN		–	–	–	–	.875 (22.23)	1.125 (28.58)
Y		.938 (23.83)	.938 (23.83)	.938 (23.83)	.938 (23.83)	.938 (23.83)	.938 (23.83)
ZB		–	–	2.625 (66.68)	2.625 (66.68)	3.375 (85.73)	3.625 (92.08)
ZF		2.875 (73.03)	2.875 (73.03)	–	–	–	–

All dimensions in inches (mm)

3/4 & 1-1/8 inch Bore Cylinders and Mounts

Code 24 No Mounts

(ANSI MX0)

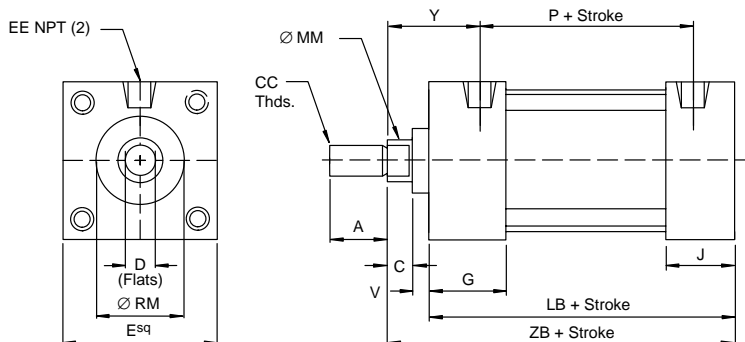
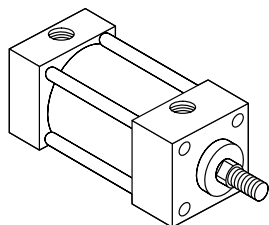

Code 25 Double Rod, Bolt Thru Mounts

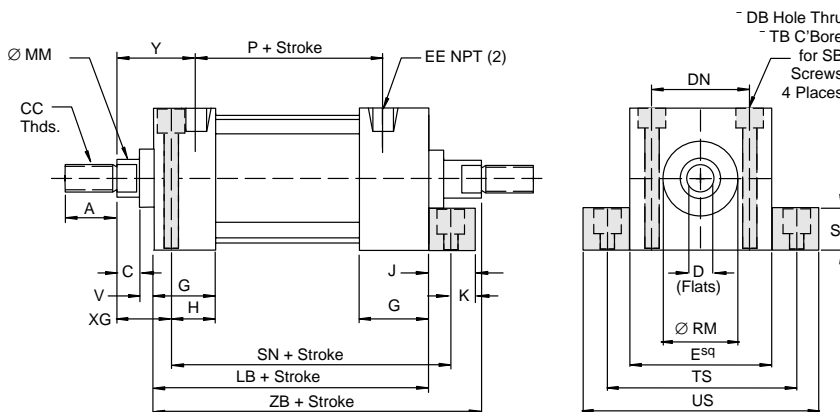
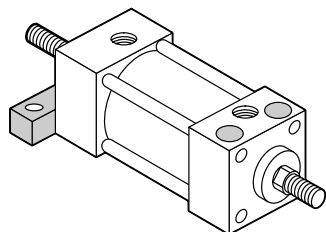

Code 47 Fixed Eye Mounts

(ANSI MP3)

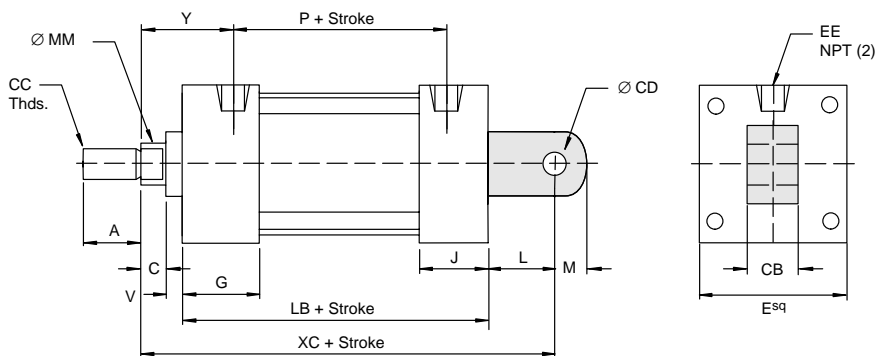
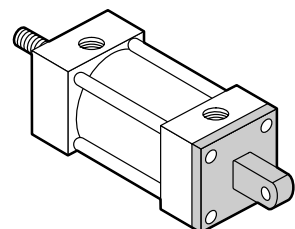

Dimension		24 No Mount (MX0)		25 Double Rod Bolt Thru Mounts (MS8)		47 Fixed Eye Mounts (MP3)	
		3/4"	1-1/8"	3/4"	1-1/8"	3/4"	1-1/8"
Ø Rod	Std.	.312 (7.92)	.375 (9.53)	.312 (7.92)	.375 (9.53)	.312 (7.92)	.375 (9.53)
	O.S.	–	.500 (12.70)	–	.500 (12.70)	–	.500 (12.70)
A	Std.	.625 (15.88)	.625 (15.88)	.625 (15.88)	.625 (15.88)	.625 (15.88)	.625 (15.88)
	O.S.	–	.750 (19.05)	–	.750 (19.05)	–	.750 (19.05)
C		.250 (6.35)	.250 (6.35)	.250 (6.35)	.250 (6.35)	.250 (6.35)	.250 (6.35)
CB		–	–	–	–	.250 (6.35)	.375 (9.53)
CC	Std.	1/4 – 28	3/8 – 24	1/4 – 28	3/8 – 24	1/4 – 28	3/8 – 24
	O.S.	–	1/2 – 20	–	1/2 – 20	–	1/2 – 20
CD		–	–	–	–	.250 (6.35)	.375 (9.53)
D	Std.	.250 (6.35)	.312 (7.92)	.250 (6.35)	.312 (7.92)	.250 (6.35)	–
	O.S.	–	.437 (11.10)	–	.437 (11.10)	–	–
DB		–	–	.172 (4.37)	.203 (5.16)	–	–
DN		–	–	.625 (15.88)	1.000 (25.40)	–	–
E		1.000 (25.40)	1.500 (38.10)	1.000 (25.40)	1.500 (38.10)	1.000 (25.40)	1.500 (38.10)
EE		.125 (3.18)	.125 (3.18)	.125 (3.18)	.125 (3.18)	.125 (3.18)	.125 (3.18)
G		.875 (22.23)	.875 (22.23)	.875 (22.23)	.875 (22.23)	.875 (22.23)	.875 (22.23)
H		–	–	.687 (17.45)	.625 (15.88)	–	–
J		.625 (15.88)	.625 (15.88)	.500 (12.70)	.500 (12.70)	.625 (15.88)	.625 (15.88)
K		–	–	.250 (6.35)	.250 (6.35)	–	–
L		–	–	–	–	.437 (11.10)	.437 (11.10)
LB		2.250 (57.15)	2.250 (57.15)	2.250 (57.15)	2.250 (57.15)	2.250 (57.15)	2.250 (57.15)
M		–	–	–	–	.250 (6.35)	.375 (9.53)
MM	Std.	.307 (7.80)	.370 (9.40)	.307 (7.80)	.370 (9.40)	.307 (7.80)	.370 (9.40)
	O.S.	–	.495 (12.57)	–	.495 (12.57)	–	.495 (12.57)
P		1.375 (34.93)	1.375 (34.93)	1.375 (34.93)	1.375 (34.93)	1.375 (34.93)	1.375 (34.93)
RM	Std.	.562 (14.27)	.750 (19.05)	.625 (15.88)	.750 (19.05)	–	–
	O.S.	–	1.000 (25.40)	–	1.000 (25.40)	–	–
SB		–	–	#8	#10	–	–
SD		–	–	2.562 (65.07)	2.500 (63.50)	–	–
ST		–	–	.375 (9.53)	.375 (9.53)	–	–
TB		–	–	.281 (7.14)	.328 (8.33)	–	–
TS		–	–	1.375 (34.93)	1.875 (47.63)	–	–
US		–	–	1.750 (44.45)	2.250 (57.15)	–	–
V		.125 (3.18)	.125 (3.18)	.125 (3.18)	.125 (3.18)	.125 (3.18)	.125 (3.18)
XC		–	–	–	–	3.062 (77.77))	3.062 (77.77))
XG		–	–	.562 (14.27)	.625 (15.88)	–	–
Y		.938 (23.83)	.938 (23.83)	.938 (23.83)	.938 (23.83)	.938 (23.83)	.938 (23.83)
ZB		2.625 (66.68)	2.625 (66.68)	3.250 (82.55)	3.250 (82.55)	–	–

All dimensions in inches (mm)

3/4 & 1-1/8 inch Bore Cylinders and Mounts

Code 48 Detachable Eye Mounts (ANSI MP4)

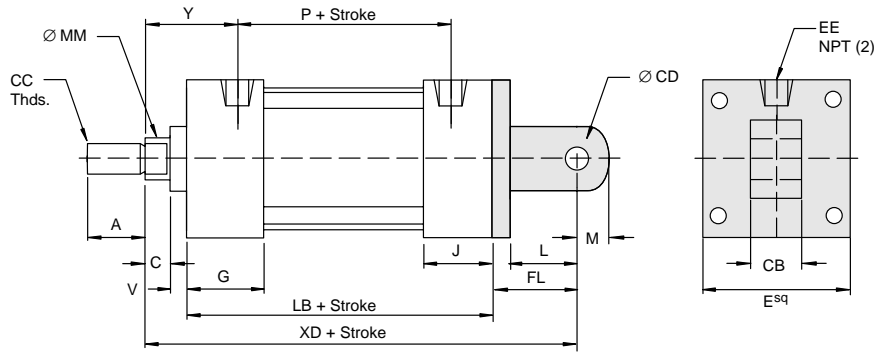
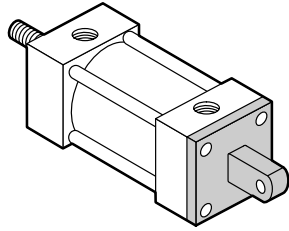

Code 50 Detachable Clevis Mounts (ANSI MP2)

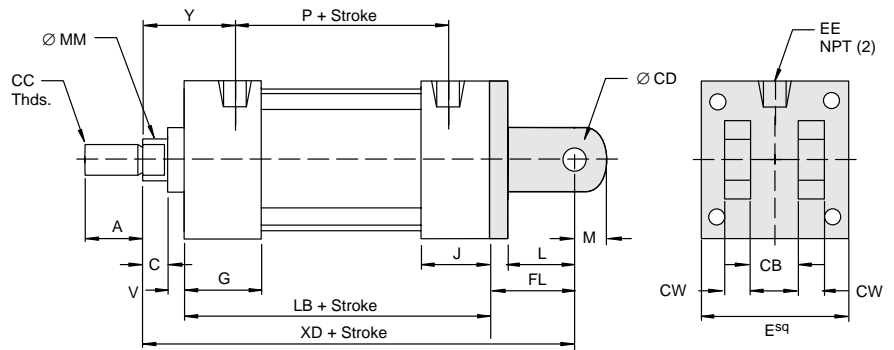
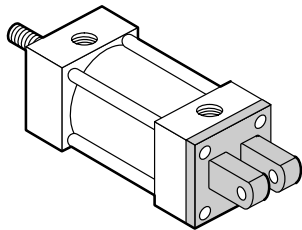

Dimension		48 Detachable Eye Mounts (MP4)		50 Detachable Clevis Mounts (MP2)	
		3/4"	1-1/8"	3/4"	1-1/8"
Ø Rod	Std.	.312 (7.92)	.375 (9.53)	.312 (7.92)	.375 (9.53)
	O.S.	–	.500 (12.70)	–	.500 (12.70)
A	Std.	.625 (15.88)	.625 (15.88)	.625 (15.88)	.625 (15.88)
	O.S.	–	.750 (19.05)	–	.750 (19.05)
C		.250 (6.35)	.250 (6.35)	.250 (6.35)	.250 (6.35)
CB		.250 (6.35)	.375 (9.53)	.250 (6.35)	.375 (9.53)
CC	Std.	1/4 – 28	3/8 – 24	1/4 – 28	3/8 – 24
	O.S.	–	1/2 – 20	–	1/2 – 20
CD		.250 (6.35)	.375 (9.53)	.250 (6.35)	.375 (9.53)
D	Std.	.250 (6.35)	.312 (7.92)	–	–
	O.S.	–	.437 (11.10)	–	–
E		1.000 (25.40)	1.500 (38.10)	1.000 (25.40)	1.500 (38.10)
EE		.125 (3.18)	.125 (3.18)	.125 (3.18)	.125 (3.18)
FL		.937 (23.80)	1.125 (28.58)	1.125 (28.58)	1.125 (28.58)
G		.875 (22.23)	.875 (22.23)	.875 (22.23)	.875 (22.23)
J		.625 (15.88)	.625 (15.88)	.625 (15.88)	.625 (15.88)
L		.437 (11.10)	.625 (15.88)	.625 (15.88)	.625 (15.88)
LB		2.250 (57.15)	2.250 (57.15)	2.250 (57.15)	2.250 (57.15)
M		.250 (6.35)	.375 (9.53)	.250 (6.35)	.375 (9.53)
MM	Std.	.307 (7.80)	.370 (9.40)	.307 (7.80)	.370 (9.40)
	O.S.	–	.495 (12.57)	–	.495 (12.57)
P		1.375 (34.93)	1.375 (34.93)	1.375 (34.93)	1.375 (34.93)
V		.125 (3.18)	.125 (3.18)	.125 (3.18)	.125 (3.18)
XD		3.562 (90.47)	3.750 (95.25)	3.750 (95.25)	3.750 (95.25)
Y		.938 (23.83)	.938 (23.83)	.938 (23.83)	.938 (23.83)

All dimensions in inches (mm)

Rod Ends for 3/4 & 1-1/8 inch Bore Cylinders

Rod End Types

In addition to selecting the correct bore, you must specify the appropriate rod size and rod end configuration for your application.

Three different inch rod end configurations are available. If a custom design is required, contact your local Vickers sales engineer, and define your requirements.

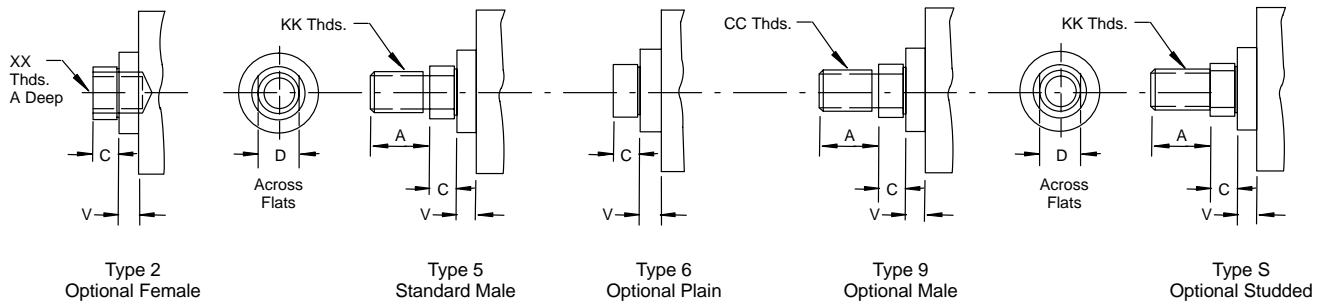

Dimension		Standard & Optional Rod Ends	
		3/4"	1-1/8"
∅ Rod	Std.	.312 (7.92)	.375 (9.53)
	O.S.	–	.500 (12.70)
A	Std.	.625 (15.88)	.625 (15.88)
	O.S.	–	.750 (19.05)
C		.250 (6.35)	.250 (6.35)
CC	Std.	5/16 – 24	3/8 – 24
	O.S.	–	1/2 – 20
D	Std.	.250 (6.35)	.312 (7.92)
	O.S.	–	.437 (11.10)
KK	Std.	1/4 – 28	5/16 – 24
	O.S.	–	7/16 – 20
V		.125 (3.18)	.125 (3.18)
XX	Std.	10 – 32	1/4 – 28
	O.S.	–	3/8 – 24

All dimensions in inches (mm)

Accessories for 3/4 & 1-1/8 inch Bore Cylinders

Rod Clevis

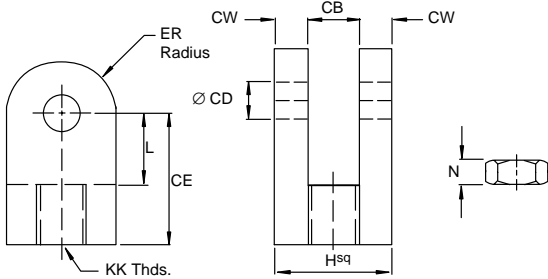

	3/4"		1-1/8"	
	VP62004A*	VP62004B*	VP62006A*	VP62006B*
CB	.250 (6.35)	.250 (6.35)	.375 (9.53)	.375 (9.53)
CD	.250 (6.35)	.250 (6.35)	.375 (9.53)	.375 (9.53)
CE	.812 (20.60)	.812 (20.60)	.875 (22.23)	.875 (22.23)
CW	.125 (3.18)	.125 (3.18)	.187 (4.75)	.187 (4.75)
ER	.250 (6.35)	.250 (6.35)	.375 (9.53)	.375 (9.53)
H	.500 (12.70)	.500 (12.70)	.750 (19.05)	.750 (19.05)
KK	1/4 - 28	5/16 - 24	3/8 - 24	1/2 - 20
L	.500 (12.70)	.500 (12.70)	.500 (12.70)	.500 (12.70)
N	.156 (3.96)	.187 (4.75)	.219 (5.56)	.312 (7.92)

*Includes Jam Nut

Rod Eye

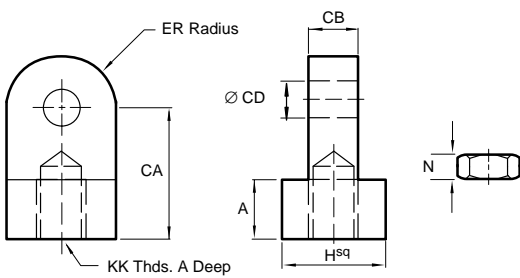

	3/4"		1-1/8"	
	VP60004A*	VP60004B*	VP60006A*	VP60006B*
A	.312 (7.92)	.312 (7.92)	.437 (11.10)	.437 (11.10)
CA	.750 (19.05)	.750 (19.05)	.875 (22.23)	.875 (22.23)
CB	.250 (6.35)	.250 (6.35)	.375 (9.53)	.375 (9.53)
CD	.250 (6.35)	.250 (6.35)	.375 (9.53)	.375 (9.53)
ER	.250 (6.35)	.250 (6.35)	.375 (9.53)	.375 (9.53)
H	.500 (12.70)	.500 (12.70)	.750 (19.05)	.750 (19.05)
KK	1/4 - 28	5/16 - 24	3/8 - 24	1/2 - 20
N	.156 (3.96)	.187 (4.75)	.219 (5.56)	.312 (7.92)

*Includes Jam Nut

Clevis Bracket

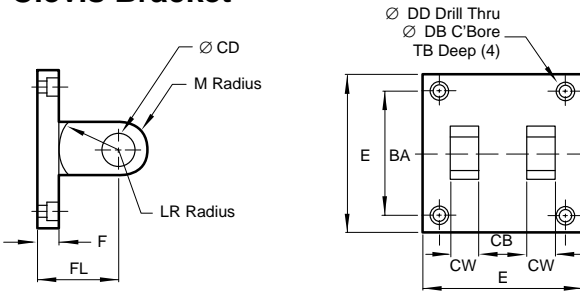

	3/4"	1-1/8"
	VP61004A	VP61006A
BA	.750 (19.05)	1.125 (28.58)
CB	.250 (6.35)	.375 (9.53)
CD	.250 (6.35)	.375 (9.53)
CW	.250 (6.35)	.250 (6.35)
DB	.250 (6.35)	.328 (8.33)
DD	.156 (3.96)	.203 (5.16)
E	1.000 (25.40)	1.500 (38.10)
F	.500 (12.70)	.500 (12.70)
FL	1.125 (28.58)	1.125 (28.58)
LR	.437 (11.10)	.625 (15.88)
M	.250 (6.35)	.375 (9.53)
TB	.125 (3.18)	.250 (6.53)

Eye Bracket

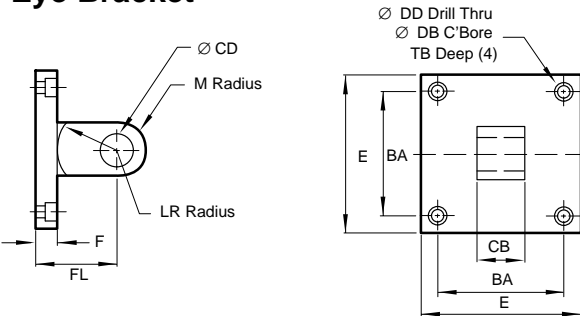

	3/4"	1-1/8"
	VP78004A	VP78006A
BA	.750 (19.05)	1.125 (28.58)
CB	.250 (6.35)	.375 (9.53)
CD	.250 (6.35)	.375 (9.53)
DB	.250 (6.35)	.328 (8.33)
DD	.156 (3.96)	.203 (5.16)
E	1.000 (25.40)	1.500 (38.10)
F	.500 (12.70)	.500 (12.70)
FL	.937 (23.80)	1.125 (28.58)
LR	.437 (11.10)	.625 (15.88)
M	.250 (6.35)	.375 (9.53)
TB	.125 (3.18)	.250 (6.53)

Clevis Pin

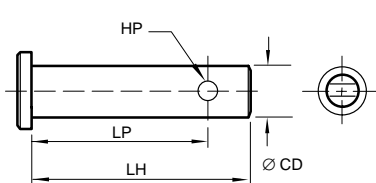

	3/4"		1-1/8"	
	VP83004B	VP83004C	VP83006B	VP83006C
CD	.250 (6.35)	.250 (6.35)	.375 (9.53)	.375 (9.53)
HP	.094 (2.39)	.094 (2.39)	.156 (3.96)	.156 (3.96)
LH	.750 (19.05)	1.000 (25.40)	1.094 (27.79)	1.250 (31.75)
LP	.656 (16.66)	.906 (23.01)	.937 (23.80)	1.032 (26.21)
Use w/	VP62004A	VP78004A	VP62006A	VP78006A
	VP62004B	VP61004A	VP62006B	VP61006A
	-	VP60004A	-	VP60006A

All dimensions in inches (mm)

Switches for 3/4 thru 8 inch Bore Cylinders

Vickers utilizes a magnetically operated, non-contact sensing system consisting of a magnet in the piston, and a sensing switch clamped to the cylinder tie rod.

One or more switches may be mounted to provide an indication of piston position.

Switches use vinyl molded cable, and are supplied with adjustable mounting brackets allowing the switches to be securely positioned anywhere along the range of piston travel.

LED indicator lights facilitate installation and troubleshooting.

Reed Switch Working Principle

Reed switch sensors contain hermetically sealed reed elements (mechanical contacts) which are open in their normal state. When a magnetic field moves within proximity of the switch, magnetism is induced into the leads and forces the contacts to close.

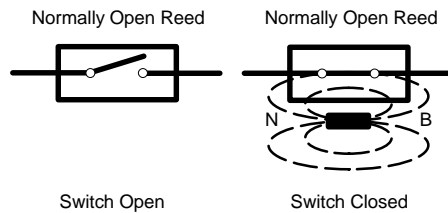

Hall Effect/Magneto-resistive Working Principle

The solid state (no moving parts) magneto-resistive sensor responds to a parallel magnetic pole by providing a digital signal to the output control circuit. This technique enables the sensing of weak magnetic fields, with no limit to the maximum strength of the magnetic field.

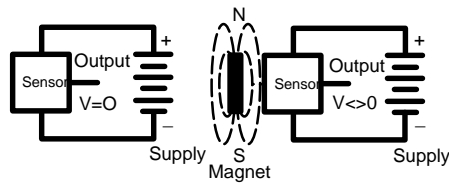

Switch and Mounting Bracket Dimensions

PS8-2 Series

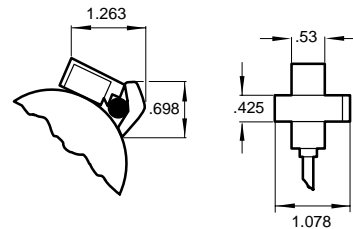

Application Recommendations and Precautions

To provide maximum reliability:

1. Always stay within the specifications and power rating limitations of the unit installed.
2. Primary and control circuit wiring should not be mixed in the same conduit.
Motors will produce high pulses that will be introduced into the control wiring if the wiring is carried in the same conduit.
3. Never connect the switch without a load present. The switch will be destroyed.
4. Some electrical loads may be capacitive. Capacitive loading may occur due to distributed capacity in cable runs over 25 feet. Use switch Model PS7-24 whenever capacitive loading may occur.

In order to obtain optimum performance and long life, magnetically operated limit switches should not be subjected to: (1) strong magnetic fields, (2) extreme temperature, and (3) excessive ferrous filing or chip buildup.

Improper wiring may damage or destroy the switch. The wiring diagram, along with the listed power ratings, must be carefully observed before connecting power to the switch.

Lower power switches are designed for signaling electronic circuits. Do not use on relay loads or with incandescent bulbs. Resistive loads only.

Specifications: 3/4 thru 2-1/2 inch Bores

*Metal Oxide Varistor surge Suppression. **Note:** All PS7 and PS* Series Switches are supplied with 9 foot leads.

Switch Model	PS8-2-04 Reed	PS8-2-31 Hall	PS8-2-32 Hall
Bore Sizes	3/4" thru 2-1/2"	3/4" thru 2-1/2"	3/4" thru 2-1/2"
Switch Type	Reed Switch *MOV & Light	Hall Effect & Light, Sourcing PNP	Hall Effect & Light, Sinking PNP
Function	SPST Normally Open	Normally Open	Normally Open
Switching Voltage	5-120 VDC/VAC 50/60 Hz	6-24 VDC	6-24 VDC
Switching Current	.5 Amp Max .005 Amp Min	.5 Amp Max	.5 Amp Max
Switching Power	10 VA	12 Watts Max	12 Watts Max
Max Voltage Drop	3.5 Volts	.5 Volts	.5 Volts
Magnetic Sensitivity	85 Gauss	85 Gauss	85 Gauss
Enclosure Classification	NEMA 6 & CSA Approved	NEMA 6 & CSA Approved	NEMA 6 & CSA Approved
Temperature Range	-22°F to +176°F	-22°F to +176°F	-22°F to +176°F
Wiring Diagrams			

Specifications: 2 thru 8 inch Bores

PS7-04 Reed	PS7-24 Reed	PS7-31 Hall	PS7-32 Hall
2" thru 8"	2" thru 8"	2" thru 8"	2" thru 8"
Reed Switch *MOV & Light	Reed Switch *MOV & Light, 3 Wire	Hall Effect & Light, Sourcing PNP	Hall Effect & Light, Sinking PNP
Normally Open	Normally Open	Normally Open	Normally Open
5-240 VDC/VAC 50/60 Hz	24-240 VAC 50/60 Hz	6-24 VAC	6-24 VAC
1 Amp Max	4 Amp Max 50 Amp Inrush	1 Amp Max	1 Amp Max
30 Watts Max	100 Watts Max	24 Watts Max	24 Watts Max
3 Volts	N/A	.5 Volts	.5 Volts
85 Gauss Parallel	85 Gauss Parallel	85 Gauss Parallel	85 Gauss Parallel
NEMA 6 & CSA Approved	NEMA 6 & CSA Approved	NEMA 6 & CSA Approved	NEMA 6 & CSA Approved
-22°F to +176°F	-22°F to +176°F	-22°F to +176°F	-22°F to +176°F

Note: For 8" bore add 9 to part number. Example: PS7-9-04

PS7 Series

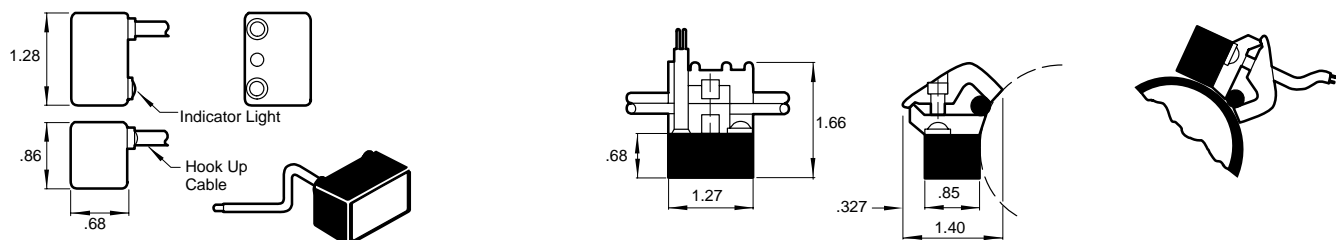

Technical Information

Operating Temperatures:

A Seal Code	-40°F to 200°F (-40°C to 93°C)
T Seal Code	-20°F to 400°F (-29°C to 204°C)

Operating Pressure:

250 psig air (17.2 bar)
 400 psig hydraulic (27.6 bar)
 Bore Sizes: 3/4", 1-1/8", 1-1/2",
 2", 2-1/2", 3-1/4", 4", 5", 6", 8"
 Note: 3/4" and 1-1/8" bores are not
 rated for hydraulic service.

Supply:

Filtered compressed air to 250 psi
 Petroleum based hydraulic fluid to
 400 psi

Lubrication:

None required
 Vickers VN/VP Air Cylinders are rated
 for "no lube added" service. All internal
 components are lubricated at time of
 assembly with a Teflon® based grease.

Series VP Materials:

Head and End Caps: anodized aluminum
 Body: aluminum, clear anodized O.D.,
 hard coat anodized I.D.
 Rod: hard chrome plated steel
 Piston: solid aluminum alloy
 Rod Bearing: cast iron,
 Teflon® coated
 Seals: urethane rod seal and wiper,
 nitrile piston seals
 Tie Rods: steel

Alternate Series VN Materials:

Body: stainless steel
 Rod: stainless steel
 Rod Bearing: stainless steel
 Tie Rods: stainless steel

Side Loading:

Cylinders are specifically designed to
 push and pull. Side loading of the piston
 rod should be avoided to ensure
 maximum operating performance and
 life.

Care should be taken during installation
 to properly align the load to be moved
 with the center line of the cylinder. The
 use of a rod alignment coupler (see
 page ##) is strongly recommended
 whenever possible.

Cylinder Weights

In pounds (kilograms)

Bore Inch (mm)	Rod Inch (mm)	Mounting Code											Add Per Inch of Stroke
		02, 24, 18	07	12, 13	23	01, 16, 17	45	10	03	08, 13, 50, 47	15, 48, 11		
1 1/2" (38.10)	5/8" (15.88)	1.9 (.86)	2.6 (1.18)	2.7 (.23)	2.1 (.95)	2.5 (1.13)	2.3 (1.04)	2.8 (1.27)	2.5 (1.13)	3.0 (1.36)	2.8 (1.27)	0.18 (.08)	
	1" (25.40)	3.4 (1.54)	4.4 (2.00)	4.6 (2.09)	3.7 (1.68)	4.1 (1.86)	3.9 (1.77)	4.6 (2.09)	4.4 (2.00)	4.8 (2.18)	4.5 (2.04)	0.35 (.16)	
2" (50.80)	5/8" (15.88)	2.8 (1.27)	3.9 (.77)	4.0 (1.81)	3.1 (1.41)	3.5 (1.59)	3.3 (1.50)	4.0 (1.81)	3.8 (1.72)	4.2 (1.91)	3.9 (1.77)	0.21 (.10)	
	1" (25.40)	3.4 (1.54)	4.4 (2.00)	4.6 (2.09)	3.7 (1.68)	4.1 (1.86)	3.9 (1.77)	4.6 (2.09)	4.4 (2.00)	4.8 (2.18)	4.5 (2.04)	0.35 (.16)	
2 1/2" (63.50)	5/8" (15.88)	3.9 (.77)	5.3 (2.40)	5.5 (2.49)	4.1 (1.86)	4.6 (2.09)	4.4 (2.00)	5.3 (2.40)	5.3 (2.40)	5.5 (2.49)	5.3 (2.40)	0.23 (.10)	
	1" (25.40)	4.5 (2.04)	5.9 (2.68)	6.1 (2.77)	4.7 (2.13)	5.2 (2.36)	5.1 (2.31)	5.9 (2.68)	6.0 (2.72)	6.1 (2.77)	5.9 (2.68)	0.38 (.17)	
3 1/4" (82.55)	1" (25.40)	7.3 (3.31)	10.8 (4.90)	11.1 (5.03)	7.7 (3.49)	8.9 (4.04)	8.2 (3.72)	11.1 (5.03)	9.7 (4.40)	11.8 (5.35)	11.4 (5.17)	0.42 (.19)	
	1 3/8" (34.93)	8.2 (3.72)	11.5 (5.22)	12.1 (5.49)	8.7 (3.95)	9.9 (4.50)	9.2 (4.17)	12.1 (5.49)	10.7 (4.85)	12.8 (5.80)	12.4 (5.62)	0.63 (.29)	
4" (101.60)	1" (25.40)	9.8 (4.45)	14.8 (6.71)	15.1 (6.85)	10.2 (4.63)	11.5 (5.22)	10.9 (4.94)	14.8 (6.71)	13.3 (6.03)	15.5 (7.03)	15.2 (6.89)	0.45 (.20)	
	1 3/8" (34.93)	10.8 (4.90)	15.5 (7.03)	16.1 (7.30)	11.2 (5.08)	12.5 (5.67)	11.9 (5.40)	15.8 (7.17)	14.3 (6.49)	16.5 (7.48)	16.2 (7.35)	0.66 (.30)	
5" (127.00)	1" (25.40)	15.1 (6.85)	22.7(10.30)	23.1(10.48)	16.1 (7.30)	18.7 (8.48)	17.6 (7.98)	22.2(10.07)	20.8 (9.43)	22.8(10.34)	22.5(10.21)	0.51 (.23)	
	1 3/8" (34.93)	16.2 (7.35)	23.5(10.66)	24.1(10.93)	17.2 (7.80)	19.7 (8.94)	18.6 (8.44)	23.2(10.52)	21.9 (9.93)	23.9(10.84)	23.5(10.70)	0.73 (.33)	
6" (152.40)	1 3/8" (34.93)	23.5(16.19)	35.6(16.15)	36.3(16.47)	24.5(11.11)	27.3(12.38)	26.6(12.07)	35.7(16.66)	32.1(14.56)	37.0(16.78)	36.3(16.47)	0.77 (.35)	
	1 3/4" (44.45)	24.8(11.27)	36.9(16.77)	37.6(17.09)	25.8(11.73)	28.3(12.86)	27.9(12.68)	35.2(15.97)	33.4(15.18)	38.3(17.41)	37.6(17.09)	1.03 (.47)	
7" (177.80)	1 3/8" (34.93)	32.1(14.56)	32.1(14.56)	32.1(14.56)	33.4(15.15)	33.5(15.20)	36.8(16.69)	36.5(16.59)	32.1(14.56)	48.9(22.18)	48.2(21.86)	1.00 (.45)	
	1 3/4" (44.45)	33.4(15.18)	33.4(15.18)	33.4(15.18)	34.7(15.77)	34.8(15.82)	38.1(17.32)	37.0(16.82)	33.4(15.18)	50.2(22.82)	49.5(22.50)	1.26 (.57)	
8" (203.20)	1 3/8" (34.93)	40.0(18.14)	40.0(18.14)	40.0(18.14)	41.3(18.73)	41.4(18.78)	45.7(20.73)	43.0(19.50)	40.0(18.14)	60.5(27.44)	59.7(27.08)	1.06 (.48)	
	1 3/4" (44.45)	47.3(21.50)	41.3(18.77)	41.3(18.77)	42.6(19.36)	42.7(19.41)	47.0(21.36)	44.3(20.14)	41.3(18.77)	61.8(28.09)	61.0(27.73)	1.32 (.60)	

All Dimensions in inches (mm). All Weights in pounds (kilograms).

Listed are the average breakaway pressures in psi for all Series VN/VP Cylinders.

If your application requires a lower breakaway pressure than indicated for a particular bore size, consult the factory.

Breakaway Pressures in PSI (bar)

Bore	A Seals		T Seals	
	Extend	Retract	Extend	Retract
3/4"	9 (.62)	10 (.69)	5 (.35)	6 (.41)
1 1/8"	6 (.41)	7 (.48)	3 (.21)	4 (.28)
1 1/2", 2", 2 1/2"	6 (.41)	7 (.48)	3 (.21)	4 (.28)
3 1/4", 4"	4 (.28)	5 (.35)	2 (.14)	3 (.21)
5", 6", 8"	3 (.21)	4 (.28)	1 (.07)	2 (.14)

Note: Breakaway pressures were established with the cylinders mounted horizontally and no load on the piston rod.

Piston Rod Diameter Selection:

Applications requiring long extend (push) strokes may require oversize piston rod diameters to prevent buckling. To determine the correct rod diameter for your application, follow these simple steps:

1. Select the force from the **Cylinder Force and Volume Chart** that is required for your application.

Force = Piston Surface Area × Operating Pressure
2. From the **Cylinder Mounting Diagrams** select the mounting style being used.
3. With the piston rod fully extended, calculate the value of D (in inches) using the formula shown or the cylinder mounting diagram selected in step #2.

4. Locate the value of D (in inches) at the bottom of the **Selection Chart**. Enter the chart at this point and move vertically upward until intersecting with the horizontal line representing the required thrust which was selected in step #1. The band within which these lines intersect represents the minimum recommended piston rod diameter.

Selection Chart

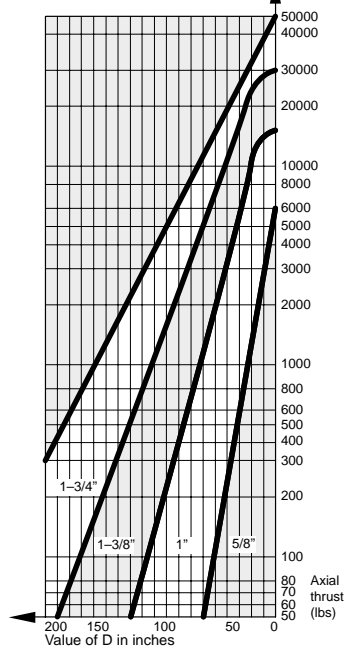

Stop Tube Selection:

Stop tubes enhance the transverse load carrying capability of a long stroke cylinder by increasing the distance between the piston and rod bearing at full extension. When the value of D (calculated from the piston rod diameter selection instructions above) is less than 40", a stop tube is not required. However, if D is 40" or more, 1" of stop tube is recommended for every 10" (or fraction thereof) over 40".

Cylinder Mounting Diagrams

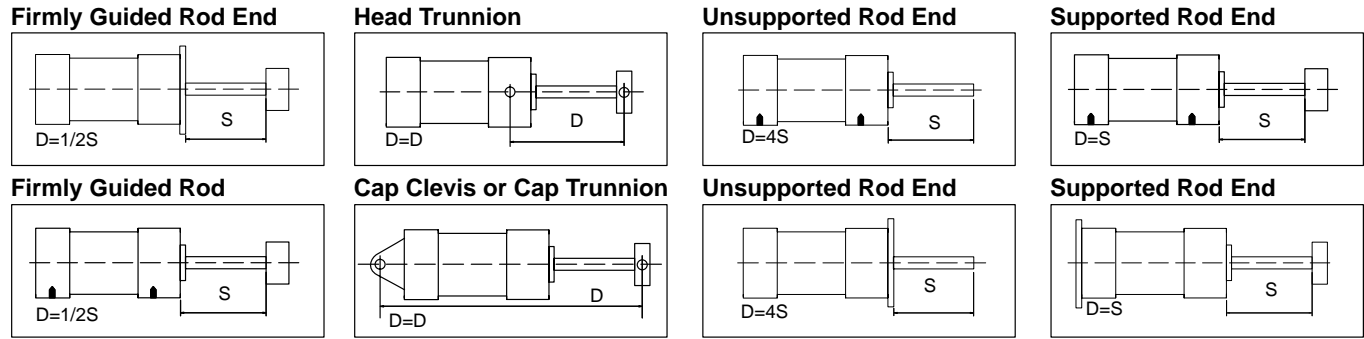

Stop Tubes

As the stroke of a cylinder increases, the resultant loads on the piston rod become greater. To keep these bearing loads from exceeding design limitations and to obtain optimum life from a cylinder, stop tubes should be specified according to the following procedure:

Stop Tube Design

Three typical stop tube designs are illustrated below.

Design A

Used for cylinders non-cushioned on the rod.

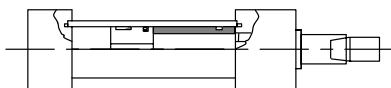

Stop Tube

SPECIFY ONE INCH OF STOP TUBE FOR EACH 10 INCHES (OR FRACTION THEREOF) OF STROKE IN EXCESS OF THE MAXIMUM LISTED IN THE FOLLOWING TABLE.

Design B

Used for cushioned hydraulic cylinders.

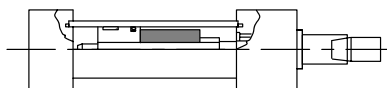

Stop Spacer

Maximum Stroke Permissible Without Stop Tube

Bore Diameter	Pivot Mount Cylinder (clevis & trunnion)	Rigid Mount Cylinder (without rod support)	Rigid Mount Cylinder (with rod support)
1 1/2" & 2"	24"	30"	48"
2 1/2" to 4"	30"	38"	48"
5" to 8"	36"	40"	48"

Design C

The best choice for a cylinder with an exceptionally long stop tube requirement. Note that the piston's effective bearing area is doubled. In addition to gaining the normal increased minimum distance between bearing points.

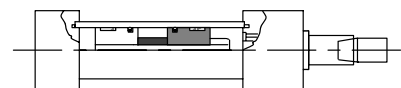

Double Piston with Spacer

Cylinder Force and Volume Charts

Extend Forces in pounds (newtons)

Bore	Piston Area in ² (cm ²)	psi (bar)						Vol. Cu. Ft. (cm ³) Displacement Per Stroke Inch
		40 (3)	60 (4)	80 (6)	100 (7)	150 (10)	200 (14)	
1½"	1.77 (11.40)	71 (315)	106 (472)	142 (629)	177 (786)	266 (1179)	353 (1570)	.00102 (29)
2"	3.14 (20.27)	126 (559)	189 (839)	251 (1119)	314 (1398)	471 (2097)	628 (2793)	.00182 (52)
2½"	4.91 (31.67)	196 (874)	295 (1311)	393 (1748)	491 (2185)	737 (3277)	982 (4368)	.00284 (80)
3¼"	8.30 (53.32)	332 (1477)	498 (2215)	664 (2953)	830 (3692)	1245 (5538)	1659 (7379)	.00480 (136)
4"	12.57 (81.07)	503 (2237)	754 (3355)	1005 (4473)	1257 (5592)	1886 (8388)	2513 (11178)	.00727 (206)
5"	19.64(126.71)	785 (3491)	1178 (5240)	1571 (6988)	1964 (8736)	2946 (13104)	3928(17472)	.01137 (322)
6"	28.27(182.39)	1130 (5026)	1696 (7544)	2262 (10061)	2827 (12574)	4240 (18860)	5654(25149)	.01837 (520)
8"	50.26(324.26)	2010 (8940)	3015 (13411)	4020 (17881)	5026 (22356)	7539 (33533)	10052(44711)	.02227 (631)

Deduct these Forces for Retract Strokes

Bore	Piston Area in ² (cm ²)	psi (bar)						Vol. Cu. Ft. (cm ³) Displacement Per Stroke Inch
		40 (3)	60 (4)	80 (6)	100 (7)	150 (10)	200 (14)	
5/8"	.307 (1.98)	12 (53)	18 (80)	25 (111)	31 (138)	46 (205)	61 (271)	.00018 (5)
1"	.785 (5.06)	31 (138)	47 (209)	63 (280)	70 (351)	118 (525)	157 (698)	.00045 (13)
1³/8"	1.485 (9.58)	59 (262)	89 (396)	119 (529)	118 (525)	222 (997)	297 (1321)	.00086 (24)
1³/4"	2.404 (15.51)	95 (423)	144 (641)	192 (854)	240 (1068)	360 (1601)	480 (2135)	.00139 (39)

Additional locations:

Vickers, Incorporated
7638 Pacific Avenue
White City, Oregon 97503-1091
U.S.A.
Phone: 503-826-2131
Fax: 503-826-3344

Vickers, Incorporated
Route 1, Box 17
250 Courtland Road
Decatur, Alabama 35603
U.S.A.
Phone: 205-353-2001
Fax: 205-351-9224

VICKERS

Vickers, Incorporated
2425 W. Michigan Avenue
Jackson, Michigan 49202-3984
U.S.A.
Phone: 517-787-7220
Fax: 517-787-3450