



## **Directional Control Valve**

**DG4V-3(S)-\*N-FJ/FW-60**

**DG4V-3(S)-\*A(L)/B(L)-FJ/FW-60**

**DG4V-3(S)-\*A(L)/B(L)-FJ/FW-60**  
**Spring offset/Spring centered**

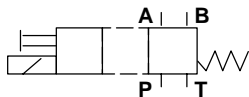

Single solenoid valves, solenoid at "A" port end. Transient condition only.

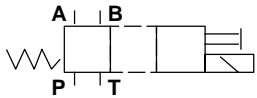

Single solenoid valves, solenoid at "B" port end. Transient condition only.

MODEL	† KNOB	⊞ CORE TUBE S/A
DG4V-3-AC	508113	508111
DG4V-3-DC	508113	508124
DG4V-3S-AC	694274	890246
DG4V-3S-DC	694272	694323

**NOTE**  
 Right hand assembly shown, for left hand assembly all parts reversed except body (& spool on "B" builds) and electrical connectors (where applicable).

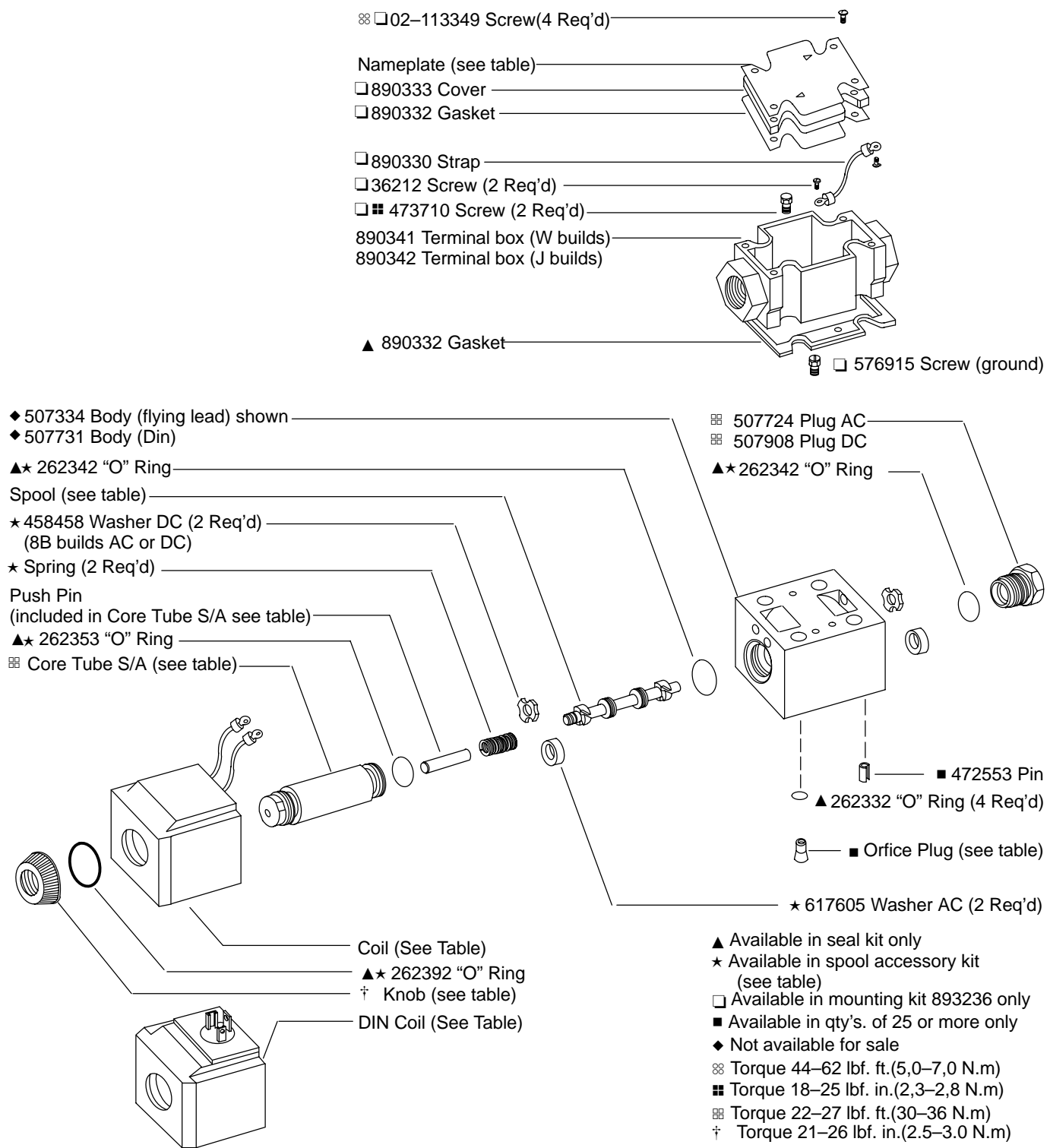

MODEL	KNOB	CORE TUBE S/A
DG4V-3-AC	508113	508111
DG4V-3-DC	508113	508124
DG4V-3S-AC	694274	890246
DG4V-3S-DC	694272	694323

### DG4V-3(S)-\*C-FJ/FW-60 Spring centered

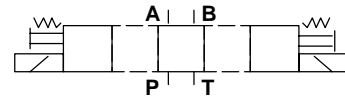

Double solenoid valves, spring centered  
Transient condition only.

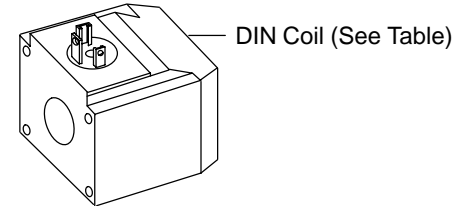
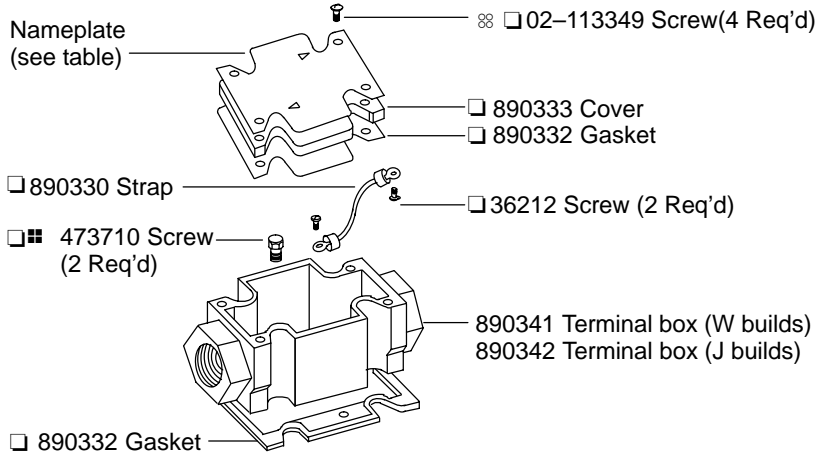

- ◆ 507334 Body (flying lead) shown
- ◆ 507731 Body (Din)

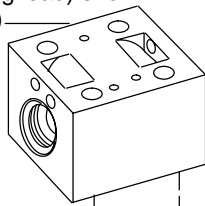

- ☒ 576915 Screw (ground)

NOTE  
Refer to other end of valve for common part numbers.

- 472553 Roll Pin
- ▲ 262332 "O" Ring (4 Req'd)
- Orifice Plug (see table)

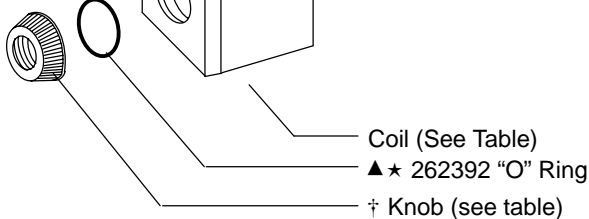
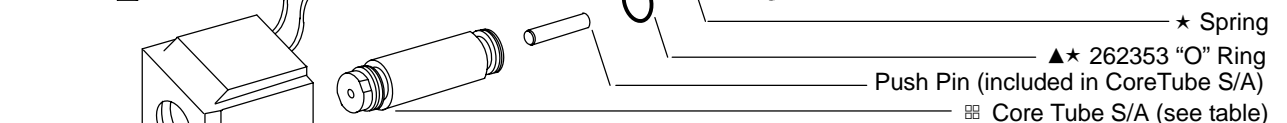
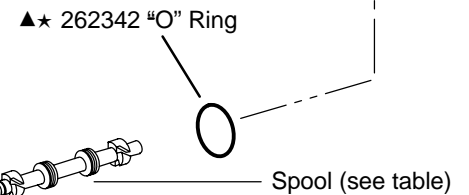
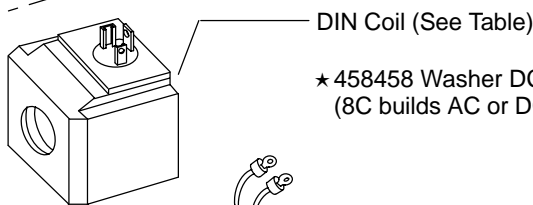

- ▲ Available in seal kit only
- ★ Available in spool accessory kit (see table)
- ☒ Available in mounting kit 893236 only
- Available in qty's. of 25 or more only
- ◆ Not available for sale
- ☒ Torque 44-62 lbf. ft. (5.0-7.0 N.m)
- Torque 18-25 lbf. in. (2.3-2.8 N.m)
- ☒ Torque 22-27 lbf. ft. (30-36 N.m)
- † Torque 21-26 lbf. in. (2.5-3.0 N.m)

**DG4V-3(S)-\*N-FJ/FW-60**  
**No spring detented**

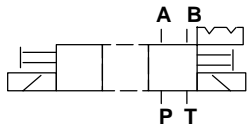

Double solenoid valves, two position, detented. Transient condition only.

MODEL	† KNOB	⊞ CORE TUBE S/A
DG4V-3-AC	508113	508111
DG4V-3-DC	508113	508124
DG4V-3S-AC	694274	890246
DG4V-3S-DC	694272	694323

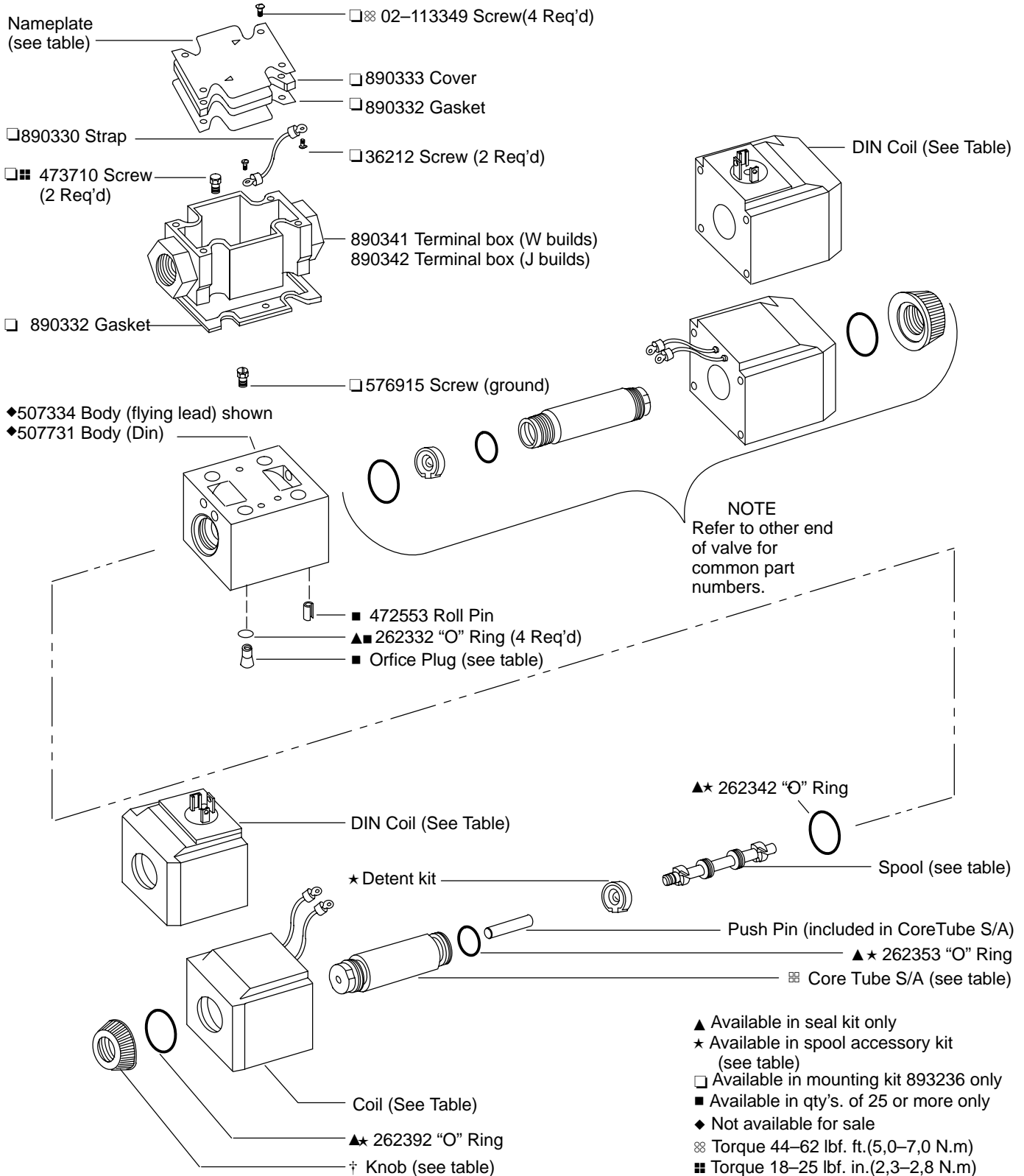

- ▲ Available in seal kit only
- ★ Available in spool accessory kit (see table)
- Available in mounting kit 893236 only
- Available in qty's. of 25 or more only
- ◆ Not available for sale
- ⊞ Torque 44-62 lbf. ft. (5,0-7,0 N.m)
- ⊞ Torque 18-25 lbf. in. (2,3-2,8 N.m)
- ⊞ Torque 22-27 lbf. ft. (30-36 N.m)
- † Torque 21-26 lbf. in. (2,5-3,0 N.m)

MODEL	† KNOB	⊞ CORE TUBE S/A
DG4V-3-AC	508113	508111
DG4V-3-DC	508113	508124
DG4V-3S-AC	694274	890246
DG4V-3S-DC	694272	694323

## DG4V-3(S)-\*A(L)/B(L)-S3/S4-FJ/FW-60 Switch option

### NOTE

Right hand assembly shown, for left hand assembly all parts reversed except body (& spool on "B" builds) and electrical connectors (where applicable).

### LIMIT SWITCH ADJUSTMENT

Remove cover and energize solenoid. Loosen switch retaining screws and position switch to obtain complete circuit from common (C) thru normally open (NO) contacts. De-energize solenoid and make sure switch returns to normally open (NO) position before re-installing cover.

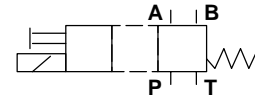

Single solenoid valves, solenoid at "A" port end. Transient condition only.

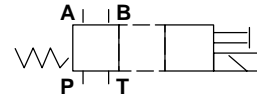

Single solenoid valves, solenoid at "B" port end. Transient condition only.

Refer to  
AL/BL-60 for  
part & kit  
numbers

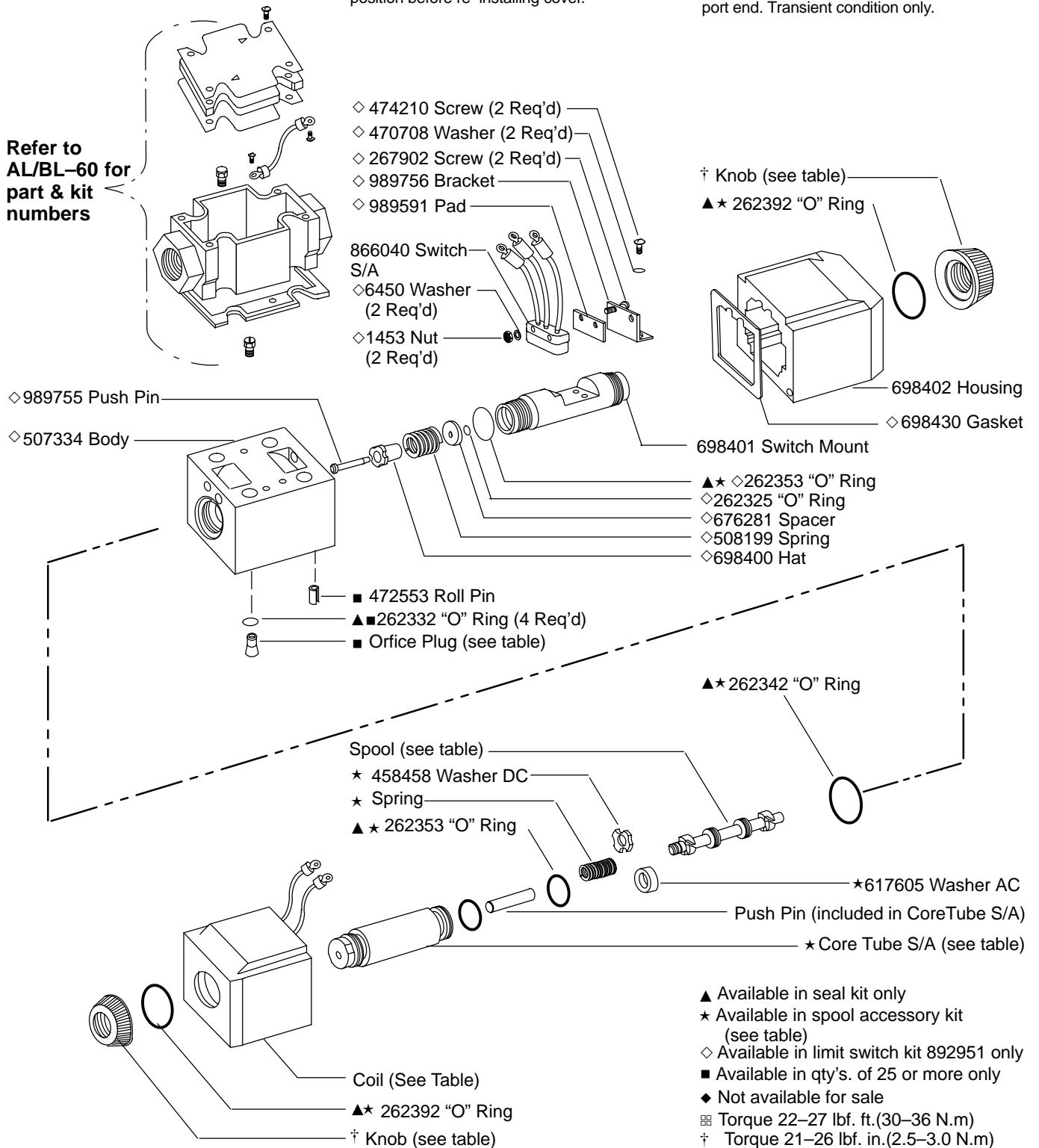

## BLANK NAMEPLATES (DG4V-3S-60 STANDARD VALVE)

MODEL CODE	NAMEPLATE
DG4V-3S-***-**-M-U-**-60	694302
DG4V-3S-***-**-M-F/FP A3/FPA5-**-60	694386
DG4V-3S-***-**-M-FPB-**-60	694363
DG4V-3S-***-**-M-FPBL-**-60	694362

## BLANK NAMEPLATES (DG4V-3-60 HIGH PERFORMANCE VALVE)

MODEL CODE	NAMEPLATE
DG4V-3-***-**-M-(S*)-U-*7-60	694303
DG4V-3-***-**-M-(S*)-U-*2/*6-60	694451
DG4V-3-***-**-M-(S*)-F/FP A3/FPA5-*7-60	694387
DG4V-3-***-**-M-FPB-**-60	865929
DG4V-3-***-**-M-FPBL-**-60	865930

### NOTE

Use blank nameplates when converting to other valve configurations. Model number, assembly number, coil designator, tank pressure, and graphic symbol must be imprinted by person performing conversion.

## RESTRICTOR PLUG

Install In P,T,A, Or B As Required

CODE	ORIFICE DIA.	PART #
03	0,30 (0.012)	694341
06	0,60 (0.024)	694342
08	0,80 (0.030)	694343
10	1,00 (0.040)	694344
13	1,30 (0.050)	694345
15	1,50 (0.060)	694346
20	2,00 (0.080)	694347
23	2,30 (0.090)	694348

## CAUTION

There is no coil/coretube/part interchangeability between the -60 design and the previous design valves.

- Seal kits
- Seal kit 858996 for (F type coil)
- Seal kit 858995 for (U type coil)
- Seal kit 859049 for (MS spool position monitor switch)

**Bolt spacer kit 893225** (spacers required when using -40 design bolts to mount a -60 design valve)

## NOTE

For satisfactory service life of these components in industrial applications, use full flow filtration to provide fluid which meets ISO 4406 cleanliness code 20/16 for up to 200 bar (3000 psi) and 18/14 for above 200 bar (3000 psi) or cleaner.

## Spool accessory kits

These kits contain the correct centering washers, centering springs, and seal kit to service or convert all valve build types. Some extra parts may exist after service or conversion (seals, spring, etc). Spool not included in kit and must be ordered separately.

<b>DG4V-3S-AC/DC</b>	<b>893240</b>
all spools, all builds, except detent builds	
<b>DG4V-3S-AC</b>	<b>893242</b>
all spools, detent builds only	
<b>DG4V-3S-DC</b>	<b>893243</b>
all spools, detent builds only	
<b>DG4V-3-AC</b>	<b>893238</b>
all spools, all builds, except 8B/8C, or detent builds	
<b>DG4V-3-AC</b>	<b>893239</b>
8B/8C builds only	
<b>DG4V-3-AC/DC</b>	<b>893242</b>
all spools, detent builds only	
<b>DG4V-3-DC</b>	<b>893239</b>
all spools, all builds, except detent	
<b>DG4V-3L-DC</b>	<b>893239</b>
all spools, low power only	
<b>DG4V-3L-AC</b>	<b>893241</b>
all spools, all builds, low power only, except 8B/8C	
<b>DG4V-3L-AC</b>	<b>893239</b>
low power, 8B/8C only	

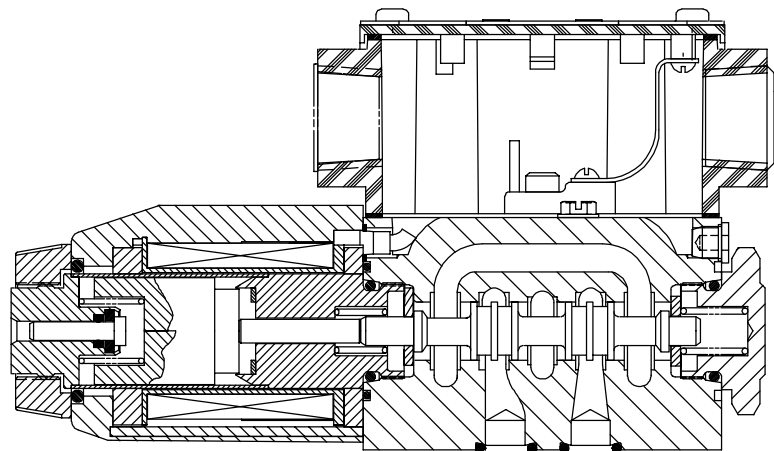

Construction of a typical single solenoid model

 Flow path during spool shift.



SPOOL/SPRING CODE	SPOOL #	SPOOL	SPOOL FUNCTIONAL GRAPHIC SYMBOLS			
♠ OA(L)	617498		OA		OAL	
OB(L)/OC	617121		OB		OBL	
♠ 2A(L)	617120		2A		2AL	
2B(L)/2C	617118		2B		2BL	
♠ 2N	617126		2N			
6B(L)/6C	617119		6B		6BL	
7B(L)/7C	617125		7B		7BL	
8B(L)/8C	458950		8B		8BL	
♠ 22A(L)	617122		22A		22AL	
22B(L)/22C	617455		22B		22BL	
24A(L)	617456		24A		24AL	
33B(L)/33C	617123		33B		33BL	
34B(L)/34C	617128		34B		34BL	
♠ 52BL/52C	617131				52BL	
♠ 56BL/56C	617132				56BL	
66B(L)/66C	698745		66B		66BL	
♠ 521B	617131		521B			
♠ 561B	617132		561B			

**SPOOL ASSEMBLY NOTES**

Spool orientation unimportant except where indicated.

♠ These spools to be installed as shown in above table with left hand end towards "A" port (reverse 180° for all "AL" builds).

**COILS (DG4V-3S-60 STANDARD VALVE)**

CODE	VOLTS AC		FLYING LEAD COIL	DIN COIL
	50 HZ	60 HZ		
NN	24		02-111630	02-111255
N	24	24	02-111631	02-111541
K	48	48	02-111633	02-111542
A	110		02-101730	02-101725
EK		115	02-111635	02-111258
B	110	120	02-101731	02-101726
DN		220	02-111638	02-111545
D	220	240	02-101733	02-101728
EM		440	02-111643	02-111262

**COILS (DG4V-3-60 HIGH PERFORMANCE VALVE)**

CODE	VOLTS AC		FLYING LEAD COIL	DIN COIL
	50 HZ	60 HZ		
NN	24		865853	865835
N	24	24		
K	48	48		
A	110		508166	507825
EK		115	866458	866456
B	110	120	508169	507833
BL	110	120	698563	698562
DN		220		02-124586
D	220	240	508170	507834
EM		440	865836	865856

**COILS (DG4V-3(S)-60 STANDARD/HIGH PERFORMANCE VALVE)  
\* Available For High Performance Valve Only**

CODE	VOLTS DC	FLYING LEAD COIL		DIN COIL
G	12	508172	507847	
GL*	12	508175	507855	
H	24	508173	507848	
HL*	24	508174	507852	
DK	32	865863	865881	
OJ	48	865864	865882	
DM	80	865865	865883	
DJ	98	865639	865637	
P	110	865866	865884	
DP	125	865867	865885	
Z	180	865868	865886	
EJ	196	865640	865638	
S	220	865869	865887	

**CAUTION**

Electrical power must be disconnected before removing/replacing terminal block, receptacle plug, indicator lights or limit switch.

**DG4V-3(S)-FTJ/FTW-60  
Terminal block.**

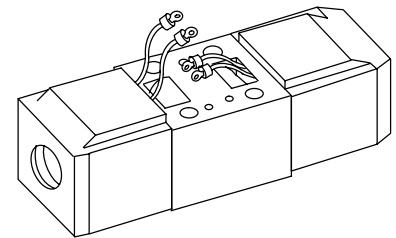
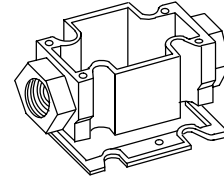
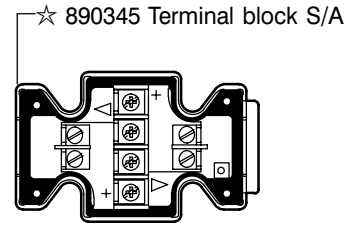

**NOTE**

Refer to valve model drawing for balance of part numbers.

**DG4V-3(S)-FTJL/FTWL-60  
Terminal block with lights.**

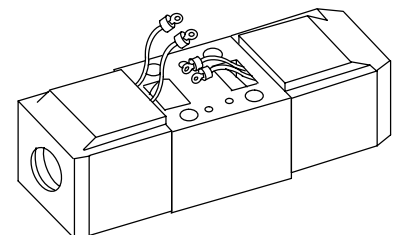
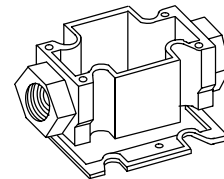
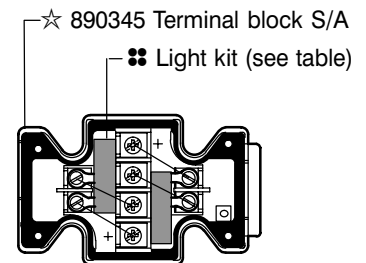

**NOTE**

Refer to valve model drawing for balance of part numbers.



**DG4V-3(S)-A/B-FPA3W-60**  
Terminal block with male receptacle

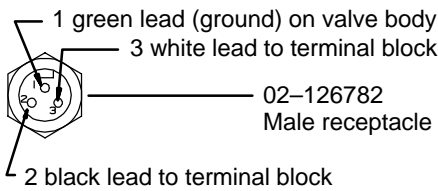
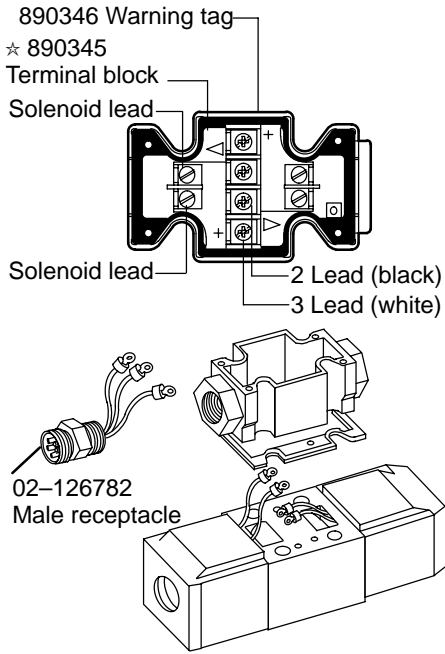

**DG4V-3(S)-A/B-FPA5W-60**  
Terminal block with male receptacle

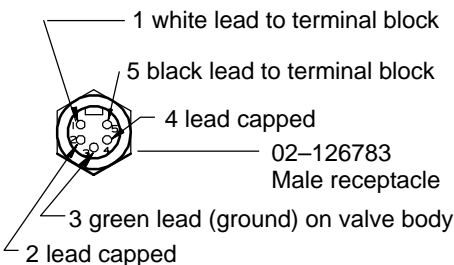
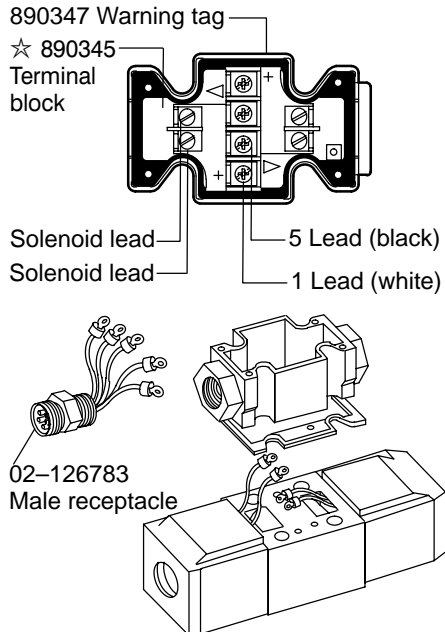

**Accessory kits**

- Terminal box accessory kit 893236 (contains all parts for mounting box)
- ★ Terminal strip kit 890345 (includes all attaching hardware).
- ◇ Limit switch kit 892951 (contains all minor parts for servicing limit switch).

**NOTE**  
Light kits cannot be installed without a terminal strip.

**Light kits (terminal strip not included)**

VOLTAGE	KIT #
12VDC	893231
24 VDC	893232
98 VDC	893233
120 VAC	893234
240 VAC	893235

For use on valves with terminal strip installed.

**Light kits (terminal strip included)**

VOLTAGE	KIT #
12VDC	893226
24 VDC	893227
98 VDC	893228
120 VAC	893229
240 VAC	893230

For use on valves without terminal strip installed).

**NOTE**  
Refer to valve model drawing for balance of part numbers.

**CAUTION**  
Electrical power must be disconnected before removing/replacing terminal block, receptacle plug, indicator lights or limit switch.

**DG4V-3(S)-C/N-FPA5W-60**  
Terminal block with male receptacle

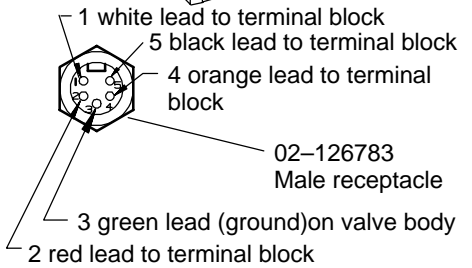
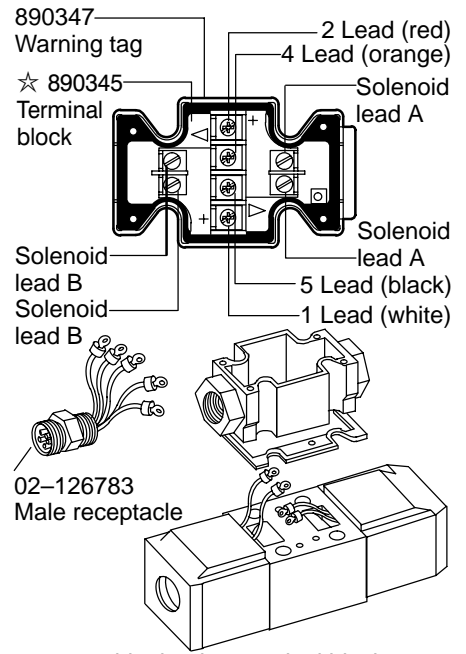

**DG4V-3(S)-A/B-S3/S4-FPA5W-60**  
Terminal block, male recept. & switch

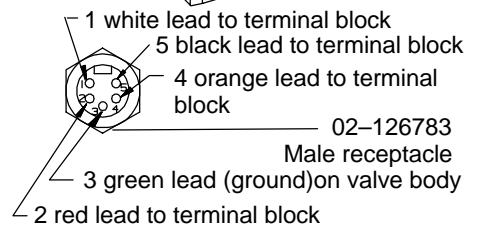
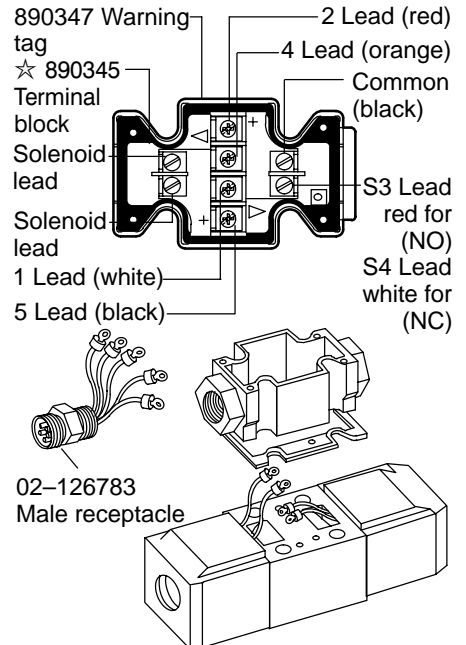

**DG4V-3(S)-\*-FPB-60**  
Instaplug male/female receptacle

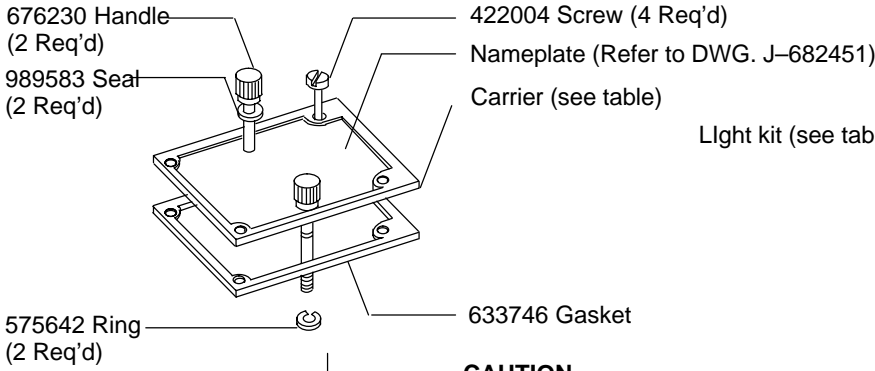

**DG4V-3(S)-\*-FPBL-60**  
Instaplug male/female receptacle with lights

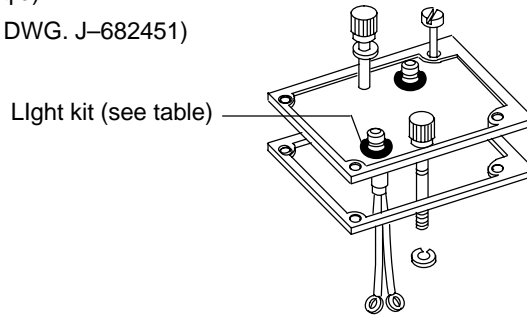

**CAUTION**  
Electrical power must be disconnected before removing/replacing terminal block, receptacle plug, indicator lights or limit switch.

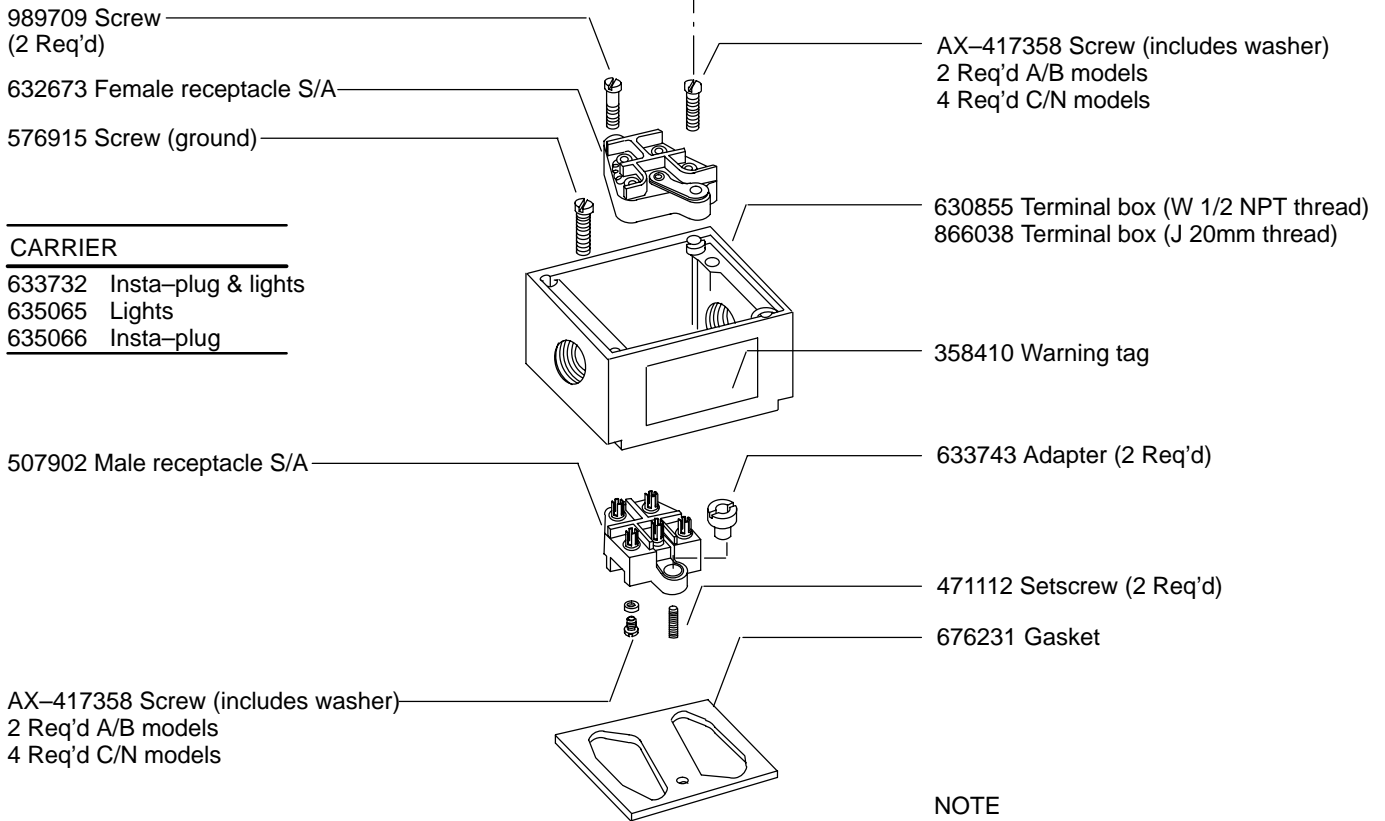

CARRIER	
633732	Insta-plug & lights
635065	Lights
635066	Insta-plug

VOLTAGE RANGE	LIGHT KIT
12V AC/DC	926499
24V AC/DC	926431
115V AC/DC	926432
230V AC/DC	926458

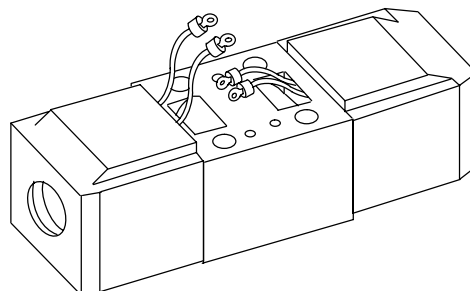

**NOTE**  
Insta-plug part numbers and assembly/disassembly sequence are the same for single and double solenoid valves.

**(PB) Insta-plug kit 893237**  
This kit is required to add the "PB" option to both standard and high performance valves. Kit contains all parts to convert a standard terminal box equipped valve to the Insta-plug (PB) version.

# Model Code

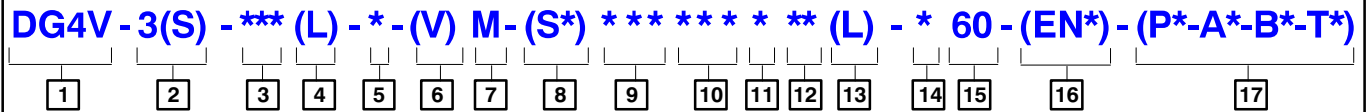

**1** **D** – Directional control valve  
**G** – Subplate mounted  
**4** – Solenoid operated  
**V** – 350 Bar (5075 psi) P, A, & B ports

**2** **Standard/High performance**

**3** – High performance 80 l/min (21 gpm) at 350 bar (5075 psi)  
**3S** – Standard performance 40 l/min (10.5 gpm) at 350 bar (5075 psi)

**3** **Spool type** (see table)

**4** **Spool/Spring arrangement**

**A** – Spring offset, single solenoid  
**AL** – Same as A but left hand build  
**B** – Spring centered, single solenoid  
**BL** – Same as B but left hand build  
**C** – Spring centered  
**F** – Spring offset, shift to center  
**N** – No spring detented

**5** **Manual override options**

**Blank** – Plain override solenoid end only  
**H** – Waterproof override solenoid end only  
**H2** – Waterproof override both ends of single solenoid  
**P2** – Plain override both ends of single solenoid  
**Y** – Lockable manual override solenoid ends only  
**Z** – No overrides in either end

**6** **Solenoid energisation identity**

**Blank** – Standard arrangement for ANSI B93 9 (energise solenoid A for flow A to P port)  
**V** – Solenoid A at port A end and/or solenoid B at port B end, regardless of spool type.  
 (All 8 spool valves are V code)

**7** **Flag**

Electrical options & features

**8** **Spool indicator switch**

Available on high performance models, DG4V-3, only.  
 Omit when not required.

For DG4V-3-\*A(L)-(Z)-(V)M-S\*-U valves having type 2 and 22 spools with proximity type DC switch:

**S1** – Switch, normally open.  
**S2** – Switch, normally closed.

For DG4V-3-\*A(L)-(Z)-(V)M-S\*-FP A5W valves having mechanical type AC switch, wired to 5 pin receptacle:

**S3** – Switch, wired normally open.  
**S4** – Switch, wired normally closed.

For DG4V-3-\*A(L)-(Z)-(V)M-S5-F(T)W/J valves having mechanical type AC switch:  
**S5** – Switch, free leads

**9** **Coil type**

**U** – ISO 4400  
**F** – Flying lead  
**SP1** – Single 6,3 series spade to IEC 760  
**SP2** – Dual 6,3 series spade to IEC 760  
**X1** – Flameproof solenoids TP EEx-d-11B-T4  
**X2** – Hazardous location solenoids to meet UL & CSA approval  
**X3** – Special protection solenoids to BASEEFA standard SFA009:1972, protection class Ex-S-11-T4

**10** **Electrical connections** (F type coil only) omit if not required

**T** – Wired terminal block  
**PA** – Instaplug male receptacle only  
**PB** – Instaplug male & female receptacle  
**PA3** – Three pin connector  
**PA5** – Five pin connector

**11** **Housing (F type coils only)**

**W** – 1/2 NPT thread wiring housing  
**J** – 20 mm thread wiring housing

**12** **Solenoid indicator lights** (omit if not required)

Not available on PA, U, SP1, & SP2 builds

**13** **Coil identification** (see table)

(\*L coils not available on DG4V-3S builds)

**14** **Tank pressure rating**

Standard performance DG4V-3S  
**5** – 100 Bar (72 psi)  
 High performance DG4V-3  
**2** – 10 Bar (145 psi)  
**4** – 70 Bar (1015 psi)  
**6** – 160 Bar (2320 psi) AC valves  
**7** – 210 Bar (3045 psi) DC valves

**15** **Design**

**16** **Special modifications** (omit if not required)

**17** **Port orifice plugs** (see table) omit if not required